

1/4

Fig. 1

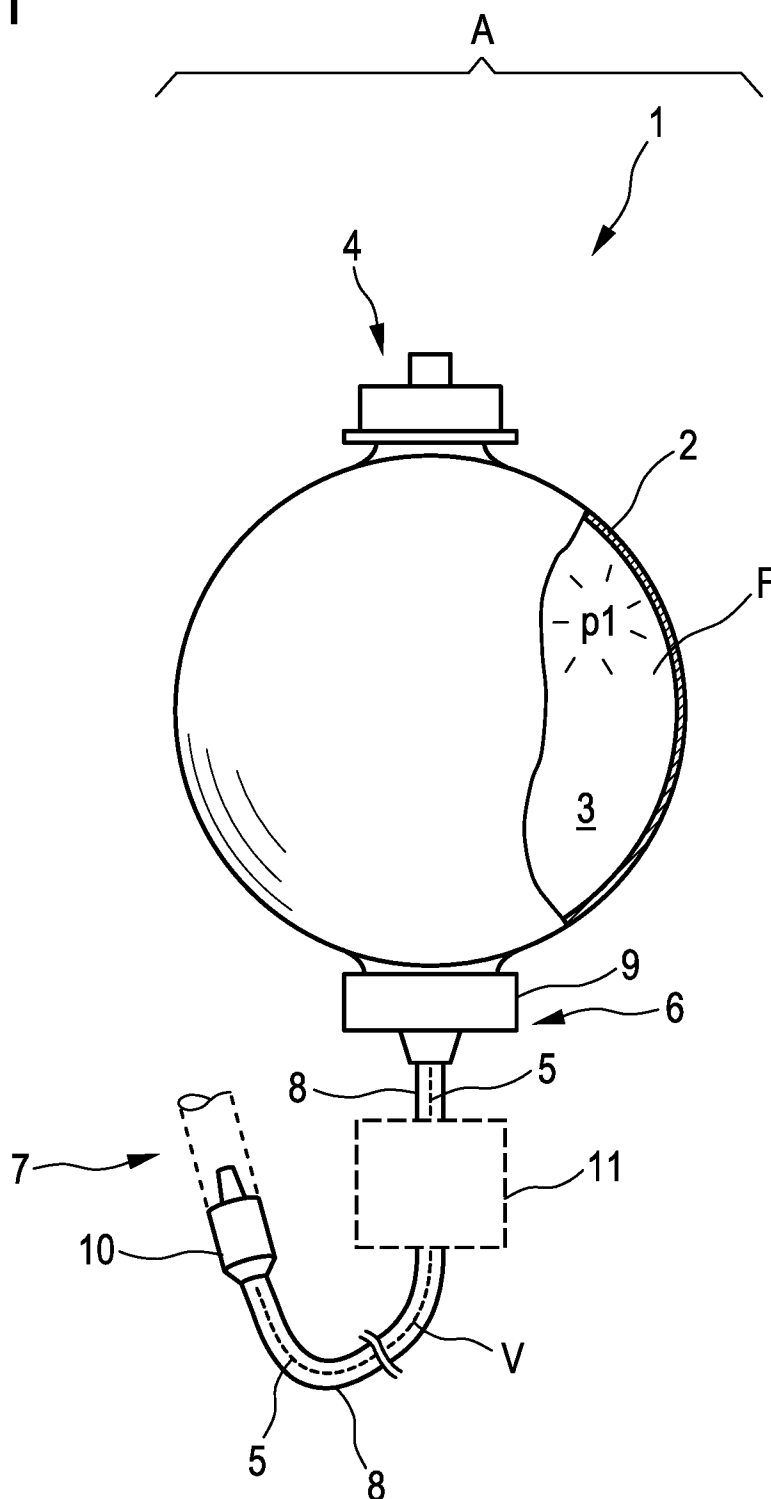



Fig. 4

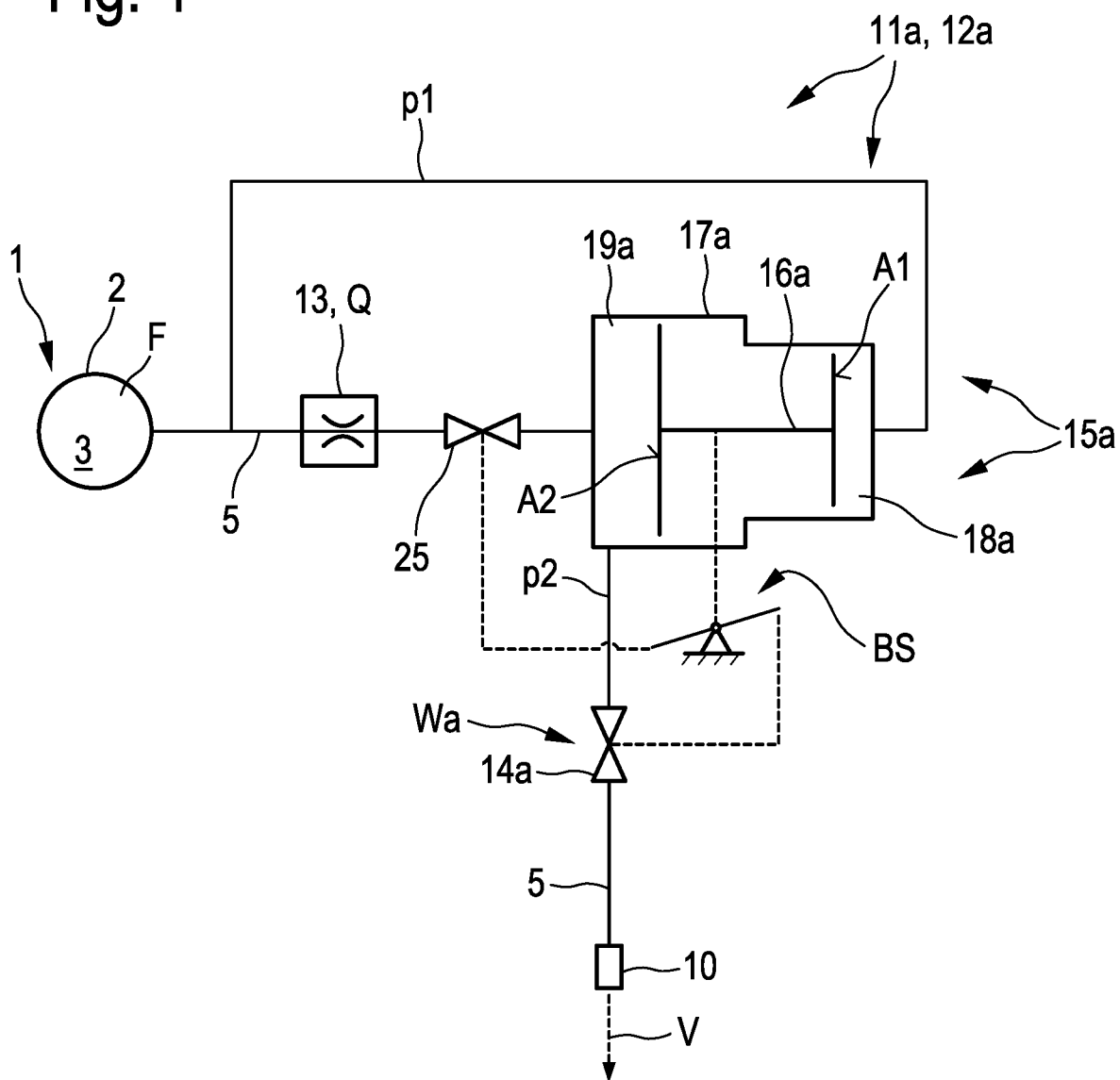

Fig. 5

