

4 / 8

Fig. 5

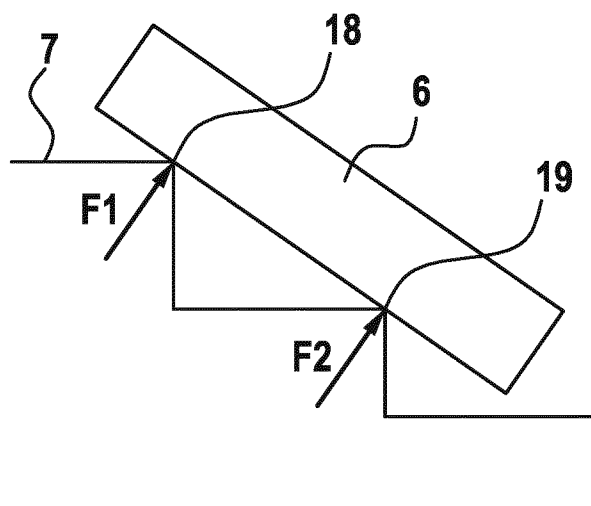

Fig. 6

