

## ePCT Document Upload

IA Number:

PCT/US2018/048879

To:

IB

Date at recipient Office:

16 November 2018 22:16:14 CET

From:

Eve Stark

Access Rights:

No access rights

Message:

The documents have been previously submitted to the USPTO as the receiving office. These copies are being transmitted to the IB for information only.

The following documents have been uploaded via ePCT:

- General Correspondence (2 documents )

Signature: Document(s) signed by Applicant/Agent included in the attachment(s)

Authentication: Sign-in with strong authentication

IN THE UNITED STATES PATENT AND TRADEMARK OFFICE  
UNITED STATES RECEIVING OFFICE

Applicant: THE REGENTS OF THE UNIVERSITY OF CALIFORNIA

Inventors: GUOCHUN JIANG  
SATYA DANDEKAR

International Application No.: PCT/US2018/048879

Title: METHODS OF REACTIVATING LATENT HUMAN IMMUNODEFICIENCY VIRUS AND RELATED COMPOSITIONS

International Filing Date: 30 August 2018 (30.08.2018)

Priority Date: 31 August 2017 (31.08.2017)

Attorney Docket No.: 47460/1102 PCT

RESPONSE TO INVITATION TO CORRECT DEFECTS  
IN THE INTERNATIONAL APPLICATION

MAIL STOP PCT  
Commissioner for Patents  
P.O. Box 1450  
Alexandria, VA 22313-1450

Attention: Arlene Pringle  
Authorized Officer

Dear Arlene Pringle:

In response to the Invitation mailed by the United States Receiving Office on 17 September 2018, transmitted herewith are ten (10) replacement sheets of formal drawings, which replace sheets 1-10 of drawing sheets that were originally filed with the above-identified PCT international application. The replacement sheets correct the physical requirements as outlined in the Invitation.

DATED this 16th day of November, 2018

Respectfully submitted,

/Barton W. Giddings/  
Barton W. Giddings  
Agent for Applicant  
Registration No. 41,036

STOEL RIVES LLP  
201 So. Main Street, Suite 1100  
One Utah Center  
Salt Lake City, Utah 84111  
Telephone: (801) 578-6920  
Facsimile: (801) 578-6999

BWG:els  
Docket No. 47460/1102 PCT

PATENT COOPERATION TREATY  
INTERNATIONAL BUREAU  
WORLD INTELLECTUAL PROPERTY ORGANIZATION  
GENEVA, SWITZERLAND

**CERTIFICATE OF ELECTRONIC TRANSMISSION**

Applicant: THE REGENTS OF THE UNIVERSITY OF CALIFORNIA

Inventors: GUOCHUN JIANG  
SATYA DANDEKAR

International Application No.: PCT/US2018/048879

Title: METHODS OF REACTIVATING LATENT HUMAN IMMUNODEFICIENCY VIRUS AND RELATED COMPOSITIONS

International Filing Date: 30 August 2018 (30.08.2018)

Priority Date: 31 August 2017 (31.08.2017)

International Bureau  
World Intellectual Property Organization  
34, Chemin des Colombettes  
1211 Geneva 20, Switzerland

Sir:

I hereby certify that this RESPONSE TO INVITATION TO CORRECT DEFECTS IN THE INTERNATIONAL APPLICATION is being electronically transmitted to the International Bureau on November 16, 2018.

Respectfully submitted,

/Barton W. Giddings/  
Barton W. Giddings  
Agent for Applicant  
Registration No. 41,036

STOEL RIVES LLP  
201 So. Main Street, Suite 1100  
One Utah Center  
Salt Lake City, Utah 84111  
Telephone: (801) 578-6920  
Facsimile: (801) 578-6999

BWG:els  
Docket No. 47460/1102 PCT

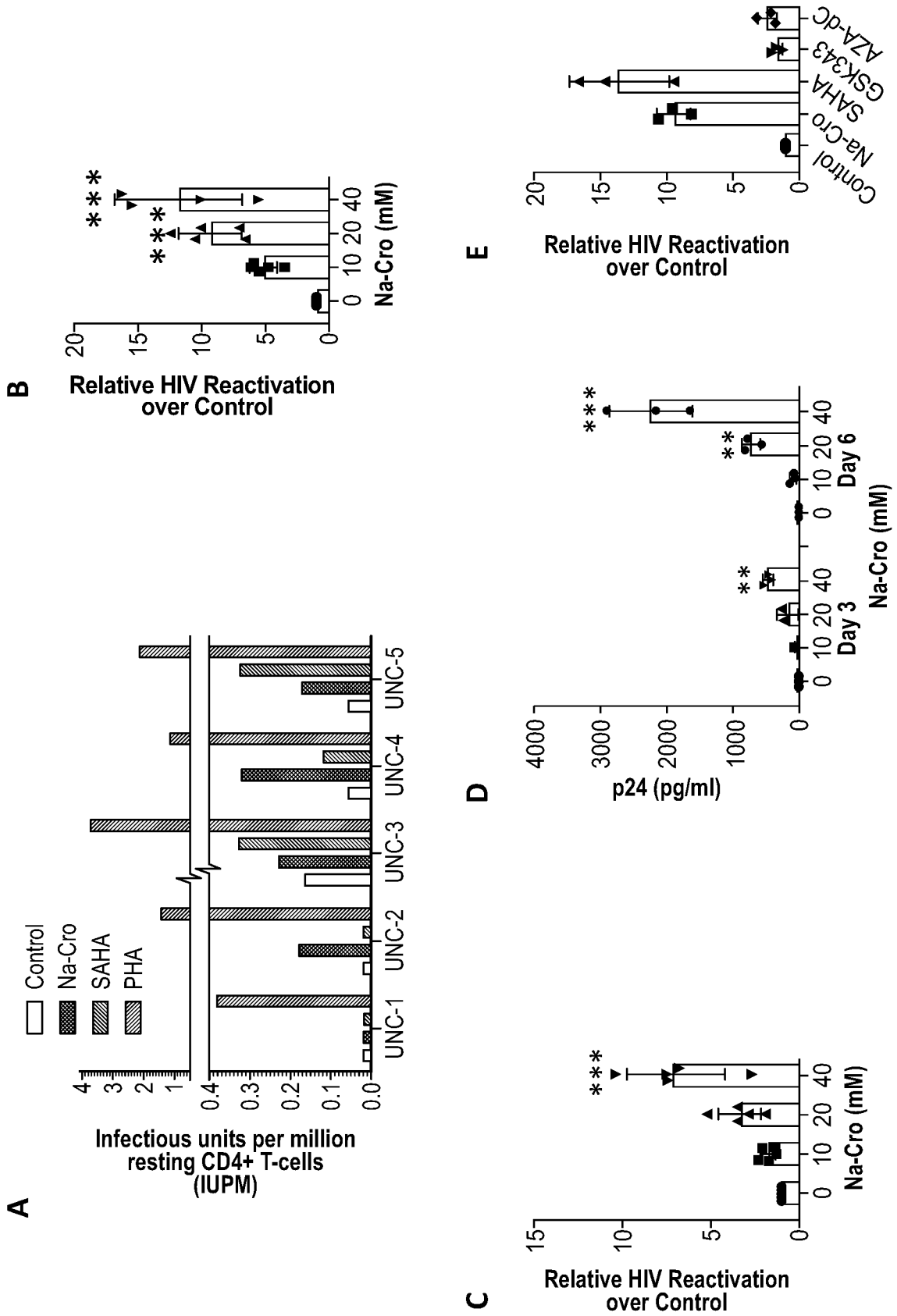

FIG. 1

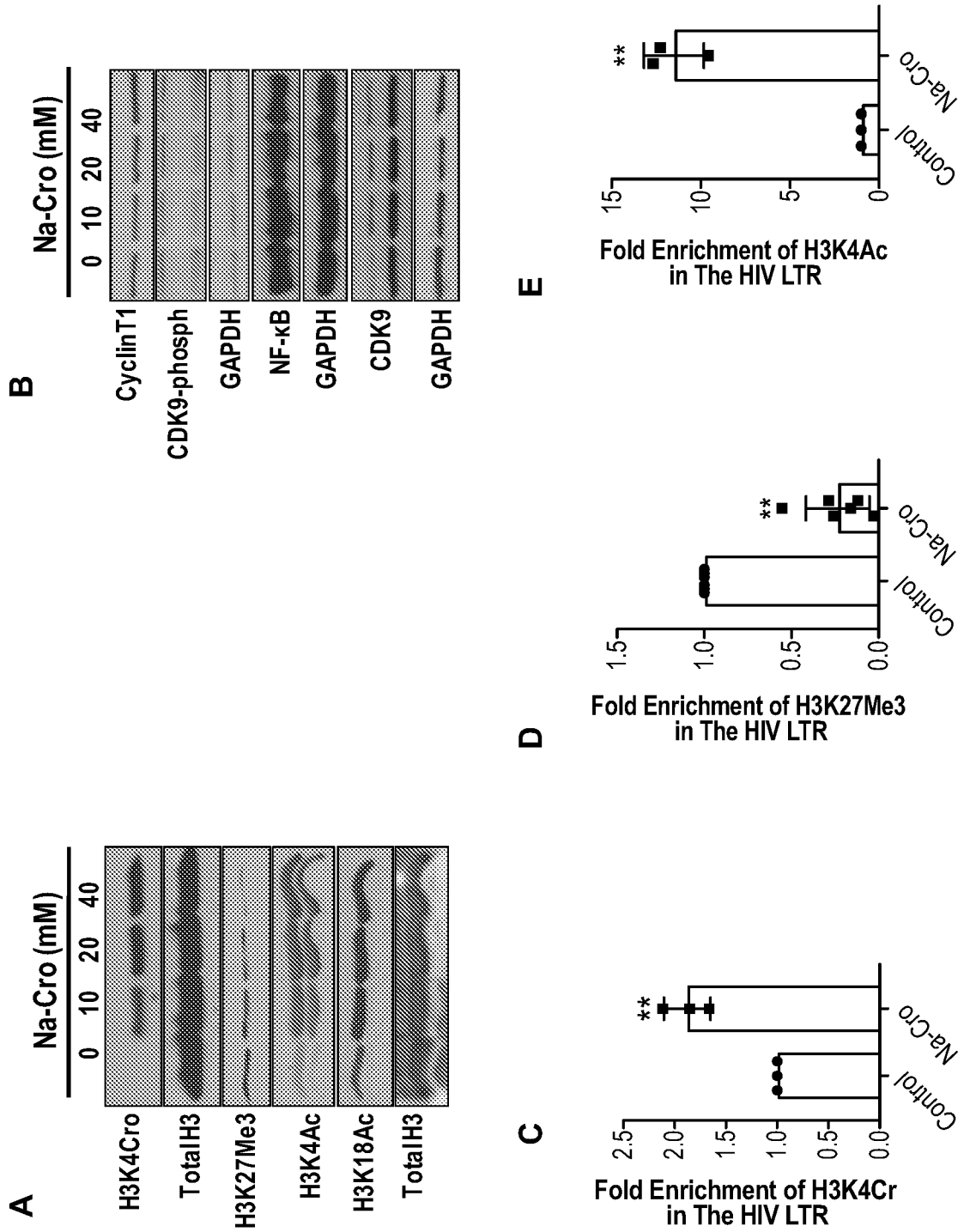
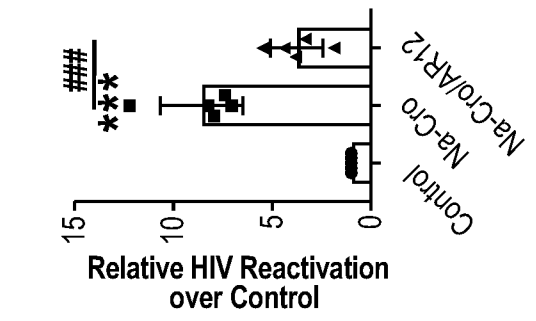
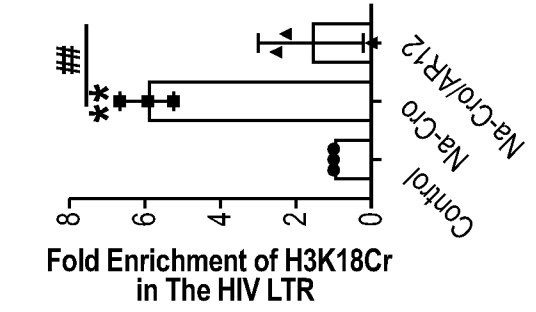
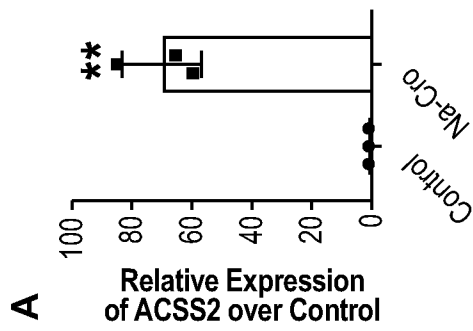
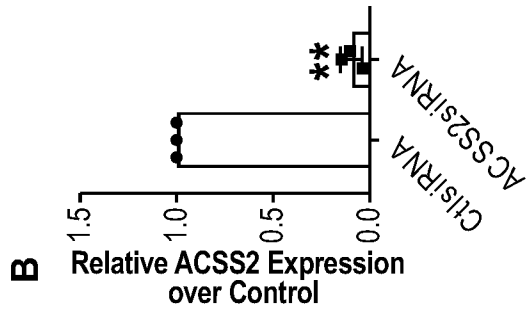
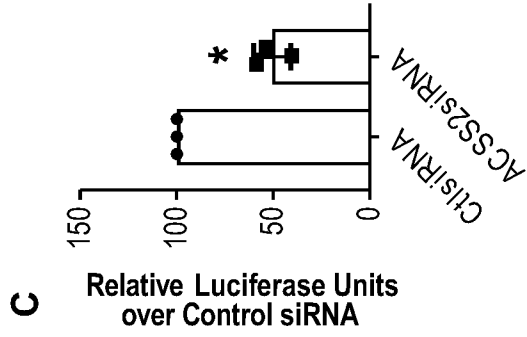

FIG. 2



**FIG. 3**

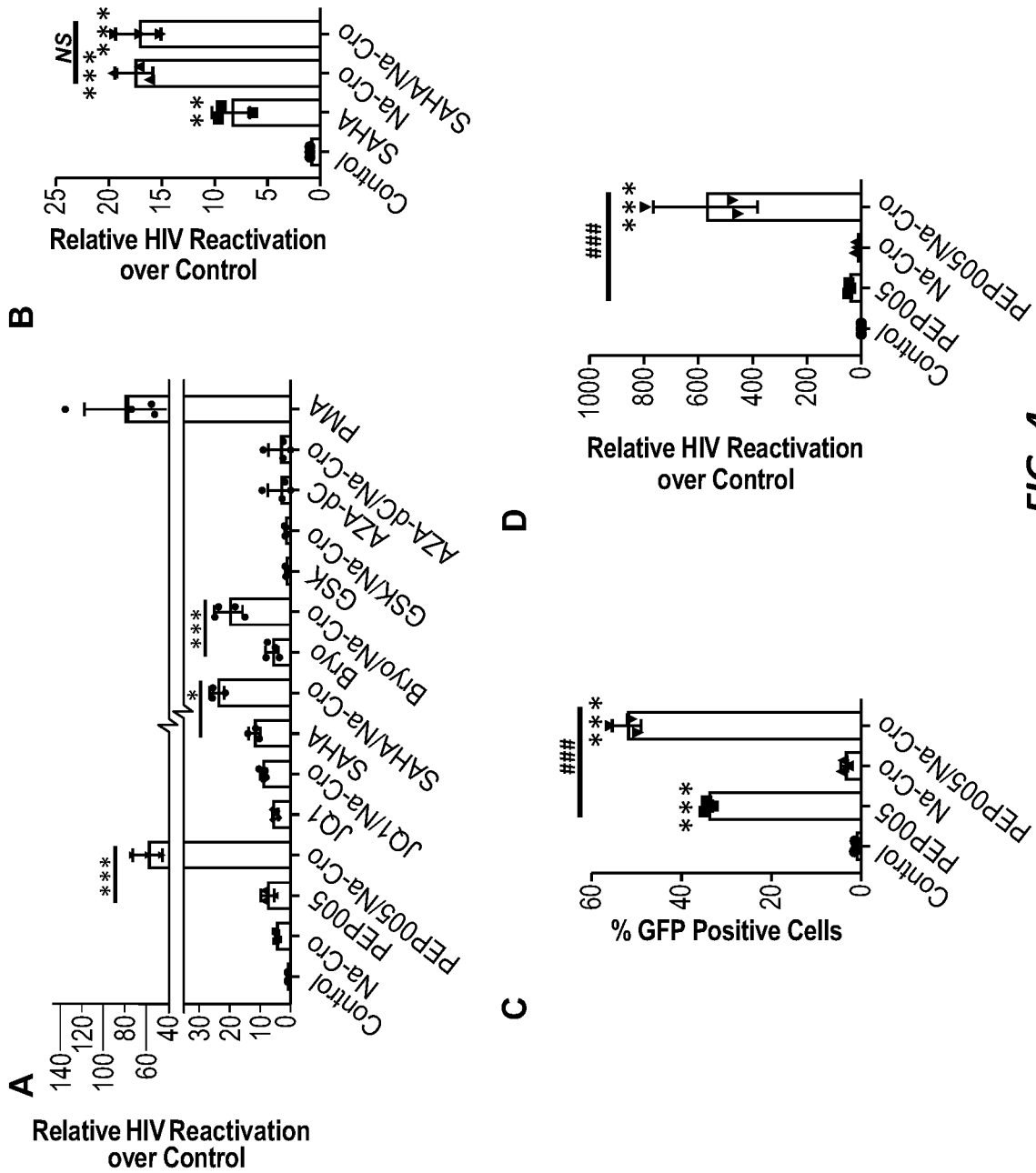
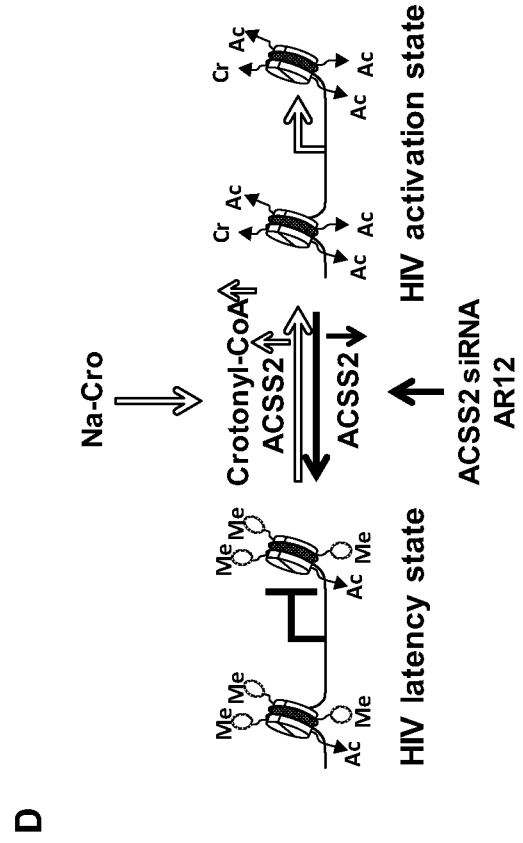
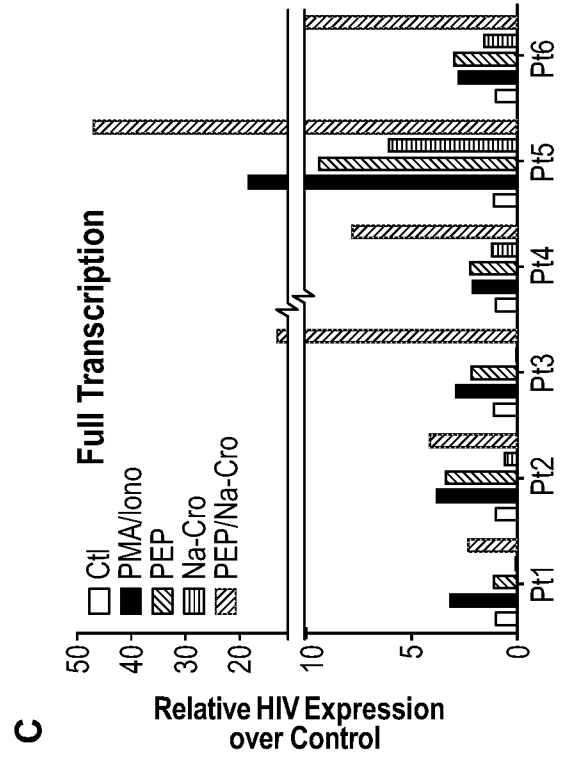
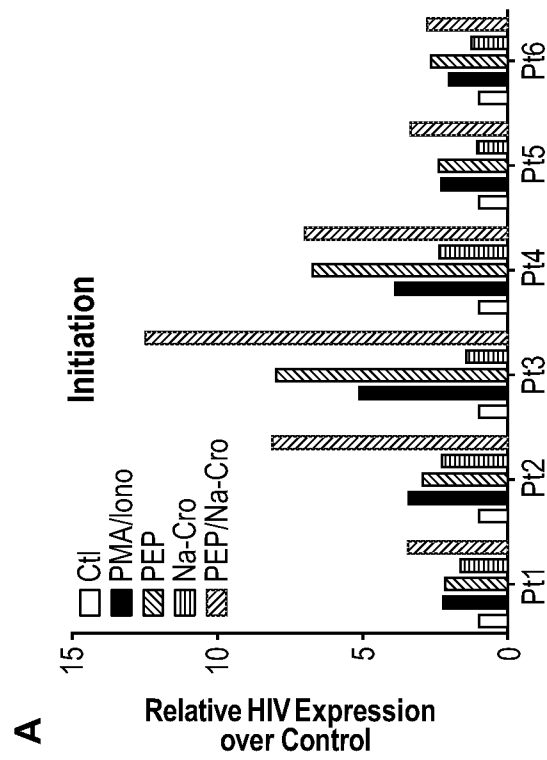
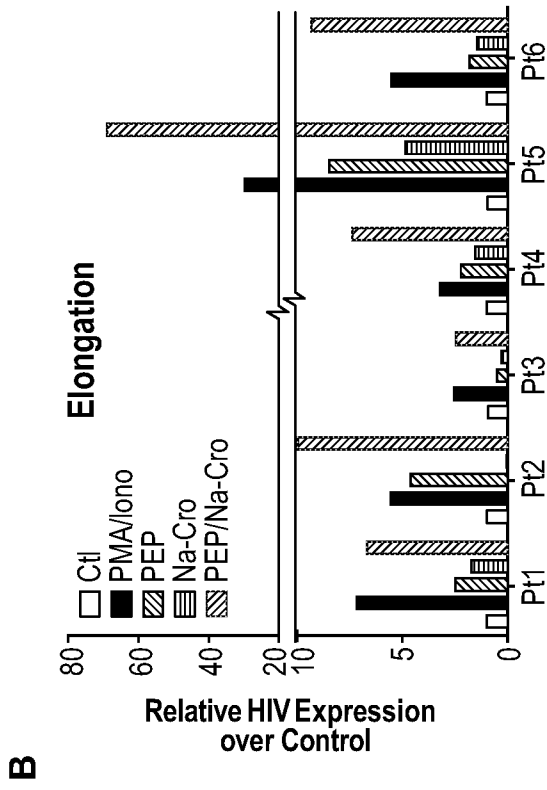
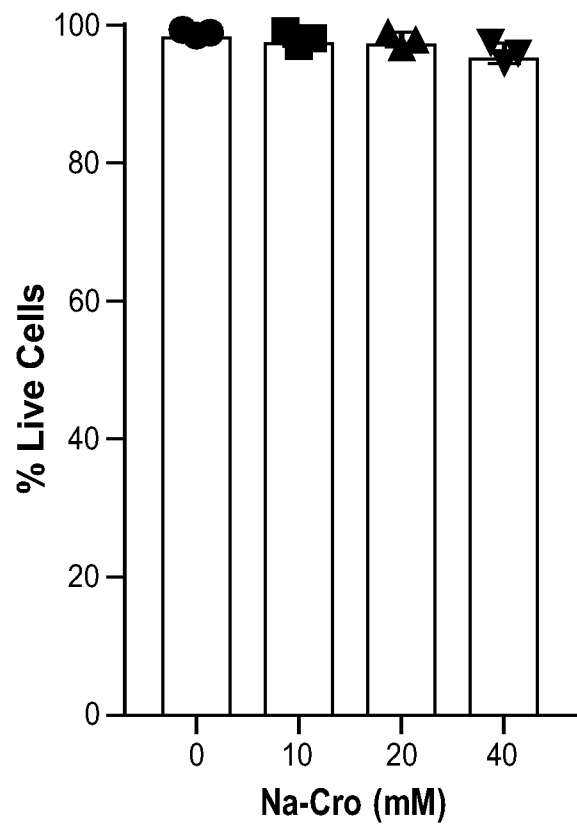

FIG. 4





**FIG. 5**



**FIG. 6**

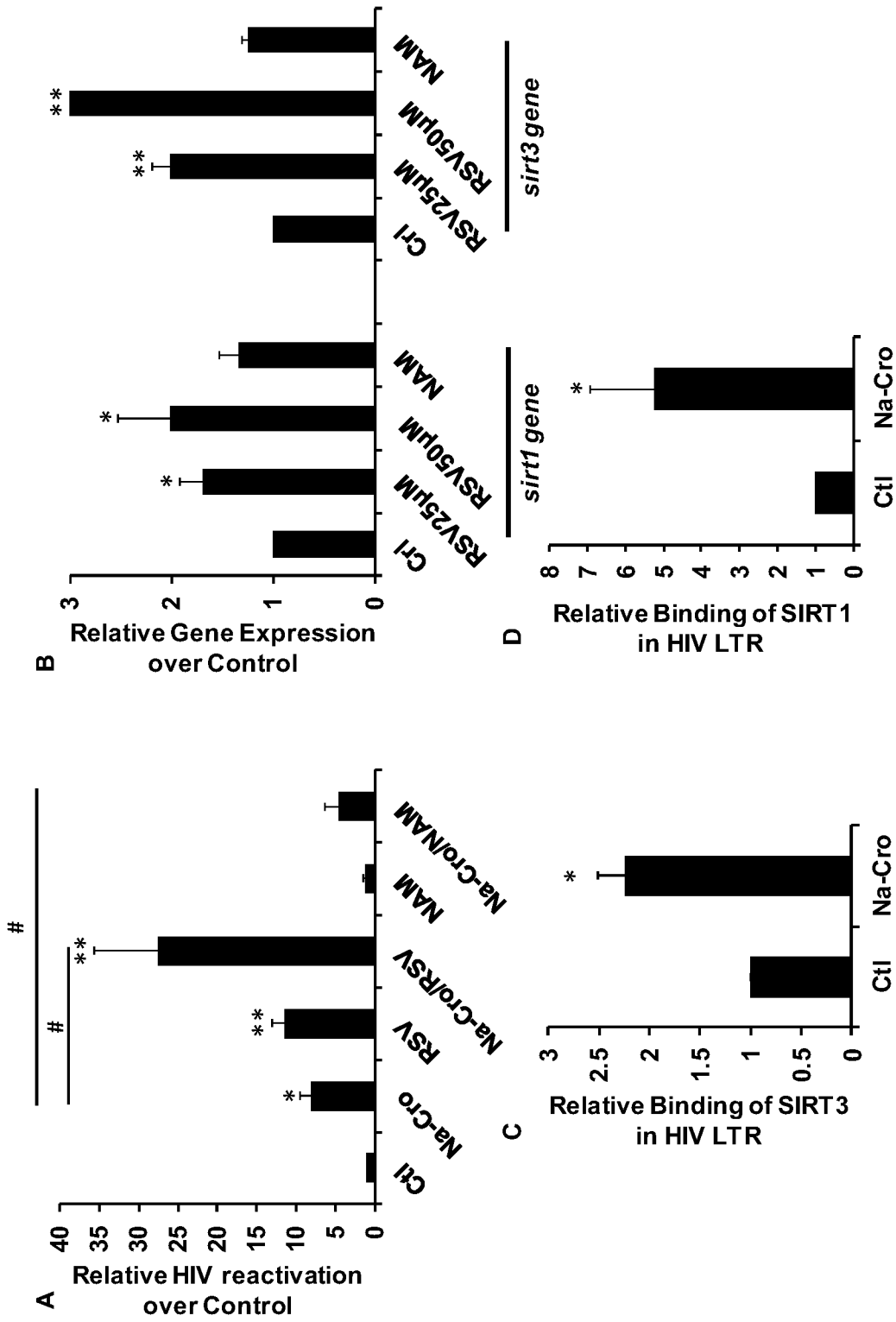

FIG. 7

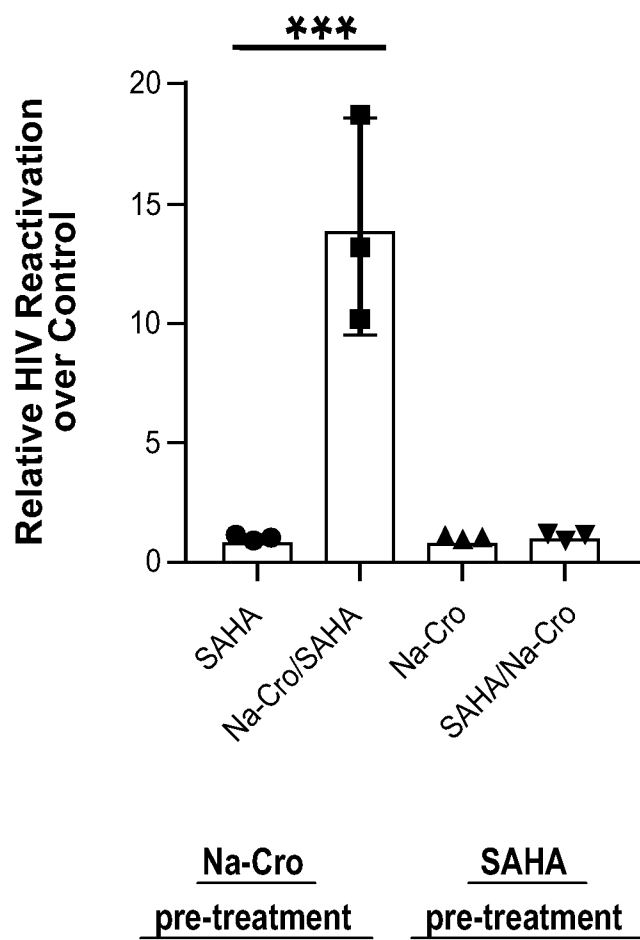

FIG. 8

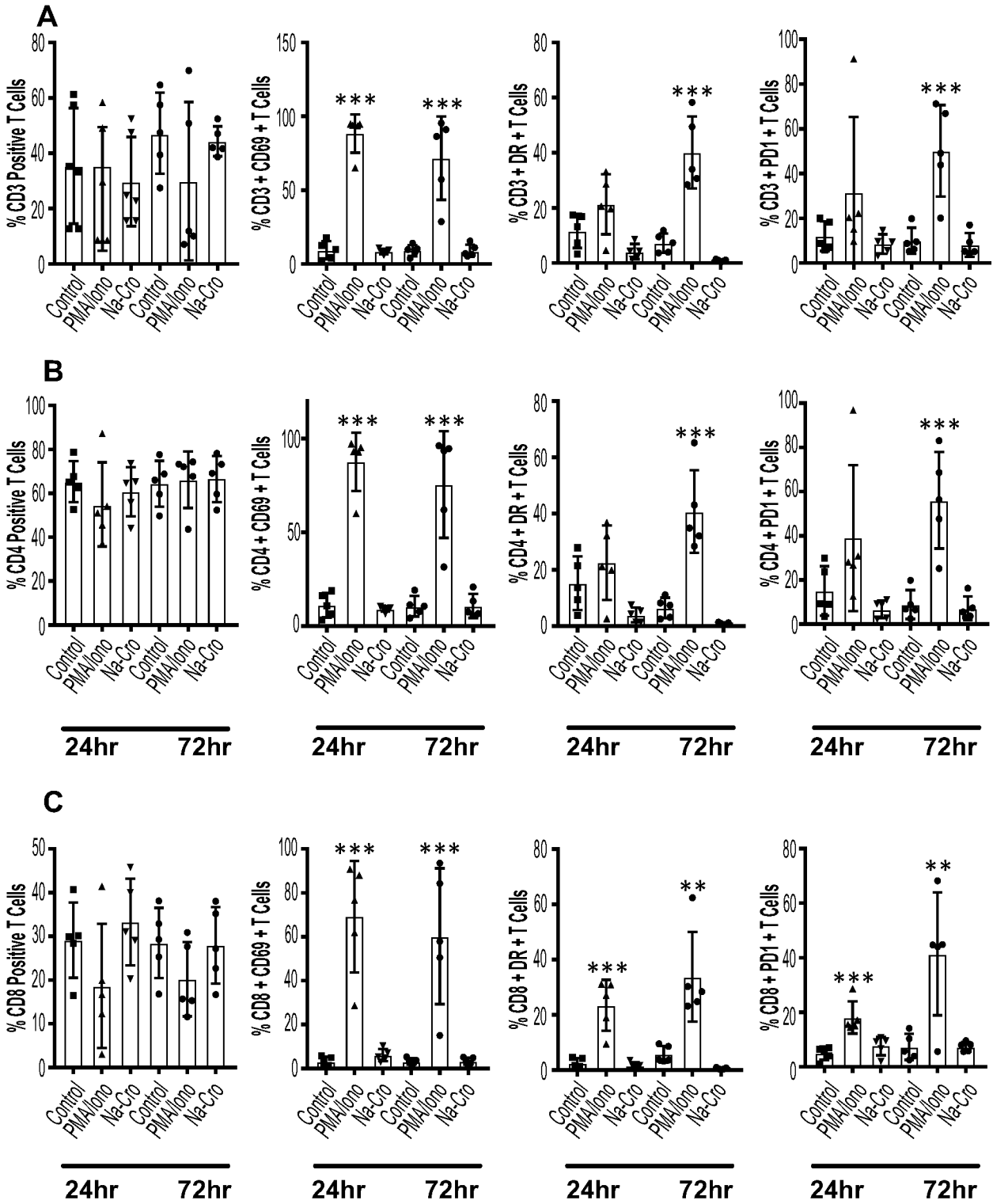

FIG. 9

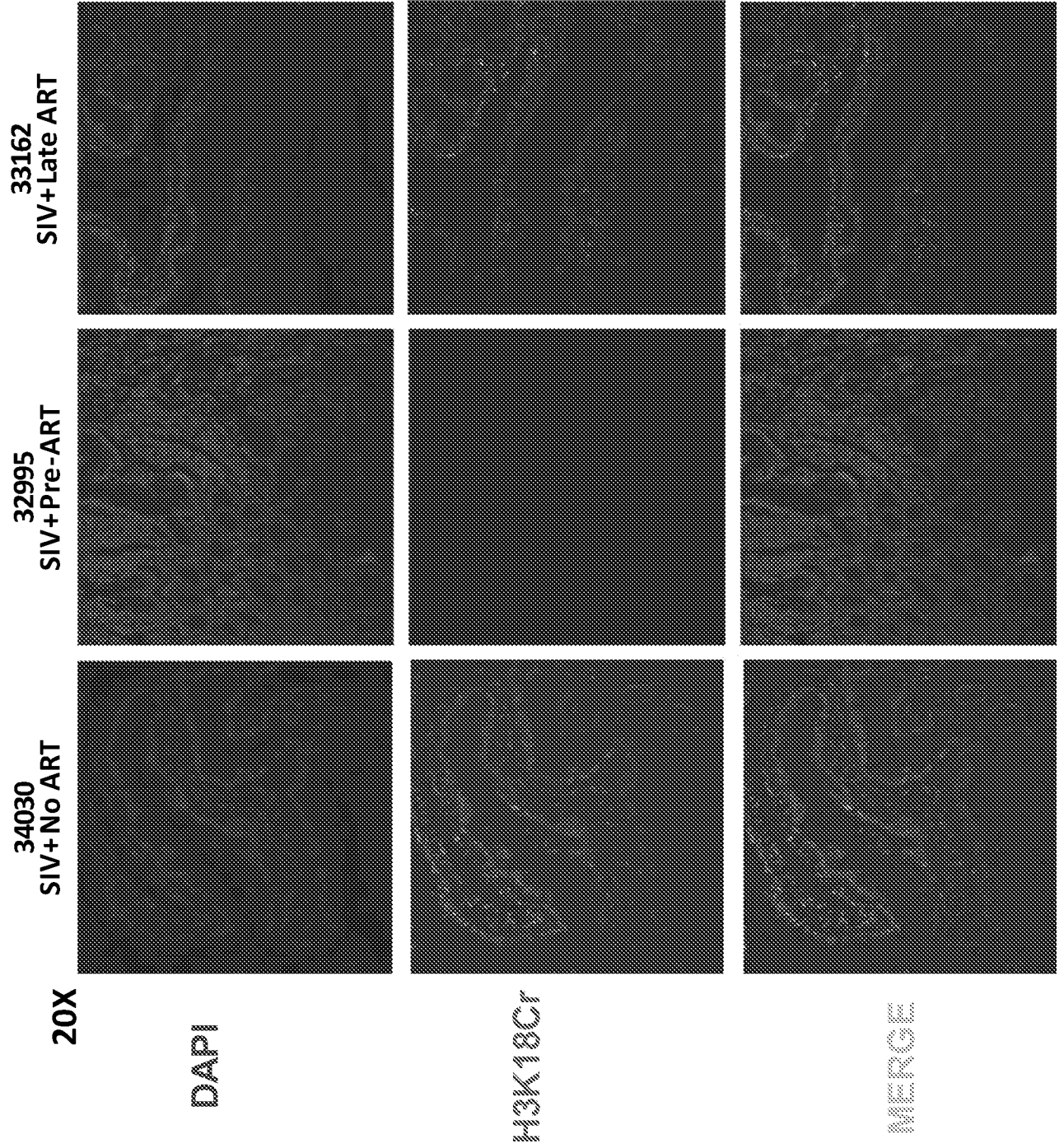

FIG. 10