

INTERMEDIATE LAYER FOR ADDED THERMAL PROTECTION AND ADHESION OF A THERMAL BARRIER LAYER TO A CERAMIC MATRIX COMPOSITE SUBSTRATE

5 FIELD OF THE INVENTION

The present invention relates to high temperature coatings, components, and processes for forming the same, and in an aspect to a thermally protective coating system for a ceramic matrix composite (CMC) substrate, the coating system comprising a thermal barrier coating (TBC) layer and an intermediate thermally
10 protective and adhesive layer disposed between the CMC substrate and the TBC layer.

BACKGROUND OF THE INVENTION

Strategies have been developed to protect turbine components from extreme
15 temperatures, such as the development and selection of high temperature materials adapted to withstand these temperatures and cooling strategies to keep the components adequately cooled during operation. State of the art superalloys are commonly used for hot gas path components of gas turbines. In view of the substantial and longstanding development in the area of superalloys, however, it
20 figures to be extremely difficult to further increase the temperature capability of superalloys.

For this reason, ceramic matrix composite (CMC) materials have been developed and increasingly utilized. Typically, CMC materials include a ceramic or a ceramic matrix material, either of which hosts a plurality of reinforcing fibers. The
25 fibers may have a predetermined orientation to provide the CMC materials with additional mechanical strength. Generally, (fiber reinforced) ceramic matrix composites are manufactured by the infiltration of a matrix slurry (e.g., alumina, mullite, silicon-containing polymers, molten silicon, or the like) into a fiber preform. While these materials may offer a high temperature resistance than superalloys, fiber
30 grains of the CMC may coarsen and lead to crack propagation at the fiber/matrix interface as firing temperatures increase. In addition, CMCs cannot be effectively

cooled under high temperatures ($>1400^{\circ}\text{C}$) or high heat flux conditions because of their lower conductivity than metals and their limitations in cooling arrangements due to manufacturing constraints.

For at least these reasons, thermal barrier coatings (TBCs) have been developed and applied to CMC substrates in order to provide a degree of thermal protection to the underlying CMC material. Once applied, the TBC provides an insulating layer over the CMC substrate surface, which may reduce the temperature the substrate is subjected to in a high temperature environment. One issue with TBCs is that due to the thermal expansion differences between the TBC and the CMC, the TBC layer is prone to crack propagation and spallation at high temperatures (e.g., $> 1200^{\circ}\text{C}$). This may lead to complete removal of the TBC, thereby leaving the underlying CMC exposed to the high temperature environment, and thus prone to thermally induced damage, such as the coarsening/crack propagation issues referenced above.

15

BRIEF DESCRIPTION OF THE DRAWINGS

The invention is explained in the following description in view of the drawings that show:

FIG. 1 is a cross-sectional view of gas turbine in accordance with an aspect of the present invention.

FIG. 2 illustrates an embodiment of a coating system in accordance with an aspect of the present invention.

DETAILED DESCRIPTION OF THE INVENTION

In accordance with an aspect of the present invention, there is provided a component formed from a ceramic matrix composite (CMC) material comprising a thermally protective coating system thereon. The thermally protective coating system comprises an outer thermal barrier coating layer (TBC layer) and an intermediate thermally protective/adhesive layer (hereinafter "intermediate layer"). When applied over a CMC substrate, the intermediate layer is disposed between the TBC layer and the CMC substrate. The intermediate layer provides for adhesion of

30

the TBC layer to the substrate and also a degree of added thermal protection to the substrate (relative to the CMC substrate alone) in the event of spallation of the TBC layer.

Now referring to the figures, FIG. 1 shows, by way of example, a gas turbine engine 100 in the form of a longitudinal cross-section. In its interior, the gas turbine engine 100 has a rotor 103, which is mounted such that it rotates about an axis of rotation 102 and has a shaft, and is also known as a turbine rotor. An intake housing 104, a compressor 105, a combustion chamber 110, in particular an annular combustion chamber, with a plurality of coaxially arranged burners 107, a turbine section 108, and an exhaust casing 109 follow one another along the rotor 103. The combustion chamber 110 is in communication with a hot-gas duct 111 where, for example, there are four successive turbine stages 112.

Each turbine stage 112 is formed, for example, from two blade or vane rings. As seen in the direction of flow of a working medium 113, a row 125 formed from rotor blades 120 follows a row 115 of guide vanes in the hot-gas duct 111. The guide vanes 130 are secured to an inner housing 138 of a stator 143, whereas the rotor blades 120 of a row 125 are fitted to the rotor 103, for example, by a turbine disc 133. A generator or machine (not shown) may be coupled to the rotor 103.

In operation, the compressor 105 intakes air 135 through the intake housing 104 and compresses it. The compressed air, which is provided at the turbine-side end of the compressor 105, is passed to the burners 107 where it is mixed with a fuel. The mixture is then burned in the combustion chamber 110 to form the working medium 113. From there, the working medium 113 flows along the hot-gas duct 111 past the guide vanes 130 and the rotor blades 120. The working medium 113 expands at the rotor blades 120, transferring its momentum, so that the rotor blades 120 drive the rotor 103 and the rotor 103 drives the machine coupled to it.

Referring to FIG. 2, there is shown a partial cross-sectional view of a component 10, which may be any component described previously herein and shown in FIG. 1. Thus, by way of example, the component 10 may comprise a component in a hot gas path of the turbine, such as a turbine blade, a turbine vane, a transition piece, ring segments, or the like. It is understood, however, that the

present invention is not so limited. In a particular embodiment, the component 10 comprises a turbine blade 120 or a (stationary) vane 130. As shown by the cross-section of FIG. 2, the component 10 includes a substrate 12 comprising a ceramic matrix composite material 14 and a thermally protective coating system 11 applied thereon. The thermal protection system 11 comprises an intermediate adhesion / thermally protective layer 16 (hereinafter "intermediate layer" 16) and a thermal barrier coating (TBC) layer 18 over the intermediate layer 16. Thus, when the thermally protective coating system 11 is applied to the substrate 12, the intermediate layer 16 is disposed between the TBC layer 18 and the substrate 12.

The substrate 12 is formed from a CMC material 14 as is known in the art. The CMC material 14 may include a ceramic or a ceramic matrix material, each of which hosts a plurality of reinforcing fibers. In certain embodiments, the CMC material 14 may be anisotropic - at least in the sense that it can have different strength characteristics in different directions. It is appreciated that various factors, including material selection and fiber orientation, can affect the strength characteristics of a CMC material. In addition, the CMC material 14 may comprise oxide, as well as non-oxide CMC materials. For example, the CMC material 14 comprises an oxide-oxide CMC material as is known in the art. An exemplary oxide-oxide CMC material for use herein is sold under the brand name A/N720-1 by COI Ceramic, Inc. of San Diego, CA (www.coiceramics.com). A/N720-1 material utilizes Nextel® N720 fibers (85% alumina and 15% silica in the form of mullite and alumina polycrystals) disposed in an alumina matrix. A/N720-1 materials can safely function without significant degradation at temperatures up to about 1200° C. In certain embodiments, the protective coating systems described herein may increase the allowable operating temperature of the CMC substrate 12 beyond 1200° C, for example, to 1300-1500° C or more.

The fibers may be provided in various forms, such as a woven fabric, blankets, unidirectional tapes, and mats. A variety of techniques are known in the art for making a CMC material and such techniques may be used in forming the CMC material 14 for use herein. In addition, exemplary CMC materials are described in U.S. Patent Nos. 8,058,191; 7,745,022; 7,153,096; 7,093,359; and 6,733,907, the

entirety of each of which is hereby incorporated by reference. As mentioned, the selection of materials may not be the only factor which governs the properties of the CMC material 14 as the fiber direction may also influence the mechanical strength of the material, for example. As such, the fibers for the CMC material 14 may have any
5 suitable orientation, such as those described in U.S. Patent No. 7,153,096. In still other embodiments, the CMC material 14 may be formed from a 3D printed ceramic matrix composite (CMC) material as set forth in PCT/US2016/059029 (the entirety of which is incorporated by reference herein) where a ceramic material is loaded into a fiber, e.g., ceramic fiber, and then 3D printed in a desired pattern to form a desired
10 structure.

The TBC layer 18 may comprise any suitable material which provides a degree of thermal protection to the underlying substrate 12. In an embodiment, the TBC layer 18 comprises a stabilized zirconia material as is known in the art, such as an yttria-stabilized zirconia (YSZ) material. An exemplary YSZ material includes
15 between about 7 to about 50 mole % yttria and between about 50 to 93 mole % zirconia. In other embodiments, the zirconia may instead or partially be stabilized with other oxides, such as magnesia, ceria, scandia, or any other suitable oxide material. In still other embodiments, the TBC layer 18 may comprise mullite, alumina, pyrochlore(s), rare earth zirconate(s), or a diffusion coating as is known in
20 the art, such as a diffusion aluminide or a diffusion platinum aluminide coating. In certain embodiments, the TBC layer 18 may comprise a columnar microstructure, which may be provided via a physical vapor deposition (PVD) process such as electron beam PVD (EBPVD), or a non-columnar microstructure.

In still other embodiments, the TBC layer 18 may comprise a ceramic
25 insulating material which includes a plurality of hollow ceramic particles dispersed in a base material, e.g., ceramic material. The hollow particles may be of any suitable dimension, and in one embodiment may be from 1-100 micron in diameter. In an embodiment, the hollow ceramic particles are spherical and comprise one or more of zirconia, alumina, mullite, ceria, and yttrium aluminum garnet (YAG), for example.

30 In addition, the TBC layer 18 typically includes a degree of porosity. In certain embodiments, the porosity may range from about 2 percent by volume to about 25

percent by volume. The TBC layer 18 may also have any suitable thickness for the intended application. In an embodiment, for example, the TBC layer 18 has a thickness of from 50 to 2000 micron, and in a particular embodiment from 50 to 350 micron, and in a further embodiment from 75 to 250 micron, although the present invention is not so limited. The TBC layer 18 may be applied over the intermediate layer 16 by any suitable process, such as by air-plasma spraying, thermal spraying, vapor deposition (e.g., EB-PVD referred to above), a sol-gel process, slurry deposition, or the like. Optionally, once applied, the TBC layer 18 may be strain relieved, such as by laser engraving channels into the TBC layer 18.

The intermediate layer 16 may comprise any suitable material (distinct from that of the TBC layer 16) which is effective to adhere the TBC layer 18 to the substrate 12 and provide a degree of thermal protection to the substrate in the event of spallation of the TBC layer 18. Upon spallation of the TBC layer 18 in a high temperature environment (e.g., $> 1200^{\circ}\text{C}$), the local temperature may increase significantly. Via the presence of the intermediate adhesive/protective layer 16, even if the TBC layer 18 is wholly or partially removed (the likelihood of which is reduced by the intermediate layer 16 adhering the TBC layer 18 to the substrate 12), the intermediate layer 16 is also adhered to the substrate 12 and provides added thermal protection to the system. In this way, the CMC substrate 12 having the thermally protective coating system 11 may have a prolonged lifetime in high temperature environments – even those exceeding 1200°C .

In accordance with an aspect, the material for the intermediate layer 16 may be selected such that its coefficient of thermal expansion (CTE) is relatively close (e.g., within 20 percent or less) of a CTE of the CMC material 14 of the substrate 12. In an embodiment, the intermediate layer 16 has a CTE value that is within 10 percent of a CTE value of the CMC material of the substrate. In this way, at the high operating temperatures of a gas turbine engine, for example, the intermediate layer 16 is more likely to remain adhered to the substrate 12 and also provide a degree of the thermal protection to the substrate 12, if needed.

In an embodiment, the intermediate layer 16 comprises a rare earth oxide. In an embodiment, the rare earth oxide may be selected from the group consisting of

yttrium oxide (yttria) (Y_2O_3), lanthanum oxide (La_2O_3), cerium oxide (CeO_2), praseodymium oxide (Pr_6O_{11}), neodymium oxide (Nd_2O_3), samarium oxide (Sm_2O_3), europium oxide (Eu_2O_3), gadolinium oxide (Gd_2O_3), terbium oxide (Tb_4O_7), dysprosium oxide (Dy_2O_3), holmium oxide (Ho_2O_3), erbium oxide (Er_2O_3), ytterbium oxide (Yb_2O_3), lutetium oxide (Lu_2O_3), scandium oxide (Sc_2O_3), and thulium oxide (Tm_2O_3), and combinations thereof. In still further embodiments, the intermediate layer 16 may comprise a garnet, such as yttrium aluminum garnet (YAG, $Y_3Al_5O_{12}$), gadolinium aluminate garnet ($Gd_3Al_5O_{12}$, GAG), terbium aluminate garnet ($Tb_3Al_5O_{12}$, TAG), and/or dysprosium aluminate garnet ($Dy_3Al_5O_{12}$, DyAG).

In particular embodiments, the intermediate layer 16 comprises an yttrium-containing material. Without wishing to be bound by theory, it is believed that the providing of an yttrium-containing material in the intermediate layer 16 promotes strong chemical bonding to the TBC layer 18 and/or to the CMC substrate 12 via diffusion of yttrium ions (Y^{3+}) from the intermediate layer 16 to the TBC layer 18 and/or the CMC substrate 12. By way of example, yttrium ion (Y^{3+}) diffusion may assist in forming a stabilized t' - ZrO_2 and Y-Al-O phase in the TBC layer 18 and/or the substrate 12 when the TBC layer 18 and/or substrate 12 comprises a zirconia-containing material, e.g., a YSZ material, and/or alumina. In an embodiment, the yttrium-containing material comprises a member selected from the group consisting of yttrium oxide, YAG, and combinations thereof. Yttrium oxide and YAG have higher fracture toughness as compared to 8YSZ, for example. In the case of TBC spallation, this moves the failure interface from CMC/ intermediate layer interface to intermediate/ TBC interface, thereby ensuring the CMC is protected from moist hot air environment at all times.

The intermediate layer 16 may be applied on a surface of the substrate 12 by any suitable process, such as by thermal spraying, vapor deposition (e.g., EBPVD), a sol-gel process, slurry deposition, or the like. In addition, the intermediate layer 16 may be provided in any suitable thickness on the substrate. In an embodiment, the intermediate layer 16 comprises a thickness of from 50 μm to 300 μm .

In view of the foregoing, there is provided a thermally protective coating system for a CMC component which comprises an intermediate thermally protective

and adhesion promoting layer between a TBC layer and a CMC substrate. The protective coating systems described herein may extend the operating temperature capabilities of combustion turbine engines having components formed from CMC materials beyond the current state of the art. In some cases, the coating systems
5 may decrease hot gas path cooling air requirements in gas turbine engines, thereby increasing engine efficiency.

While various embodiments of the present invention have been shown and described herein, it will be obvious that such embodiments are provided by way of example only. Numerous variations, changes and substitutions may be made
10 without departing from the invention herein. Accordingly, it is intended that the invention be limited only by the spirit and scope of the appended claims.

CLAIMS

What we claim is:

1. A component (10) comprising:
a substrate (12) comprising a ceramic matrix composite material (14);
5 a thermal barrier coating layer (18) disposed over the substrate (12); and
an intermediate thermal protection and adhesion layer (16) between the
thermal barrier coating layer (18) and the substrate (12) effective to adhere the
thermal barrier coating layer (18) to the substrate (12) and provide a degree of
thermal protection to the substrate (12) upon spallation of the thermal barrier coating
10 layer (18).
2. The component (10) of claim 1, wherein the intermediate layer (16)
comprises a rare earth oxide.
- 15 3. The component (10) of claim 1, wherein the intermediate layer (16)
comprises an yttrium-containing material.
4. The component (10) of claim 1, wherein the yttrium-containing material
comprises a member selected from the group consisting of yttrium aluminum garnet,
20 yttrium oxide, and combinations thereof.
5. The component of claim 1, wherein the intermediate layer (16)
comprises a thickness of from 50 micron to 300 micron.
- 25 6. The component (10) of claim 1, wherein the thermal barrier coating
layer (18) has a thickness of from 50 to 2000 micron.
7. The component (10) of claim 1, wherein the thermal barrier coating
layer (18) comprises a zirconia-based material.

8. The component (10) of claims 1 to 7, wherein the ceramic matrix composite material (14) comprises an oxide-oxide material.

ABSTRACT

The present invention is directed to a component (10) including a substrate (12) of a ceramic matrix composite material (14); a thermal barrier coating layer (18) disposed over the substrate (12); and an intermediate thermal protection and
5 adhesion layer (16) between the thermal barrier coating layer (18) and the substrate (12). The intermediate layer (16) is effective to adhere the thermal barrier coating layer (18) to the substrate (12) and provide a degree of added thermal protection to the substrate (12) in the event of spallation of the thermal barrier coating layer (18).

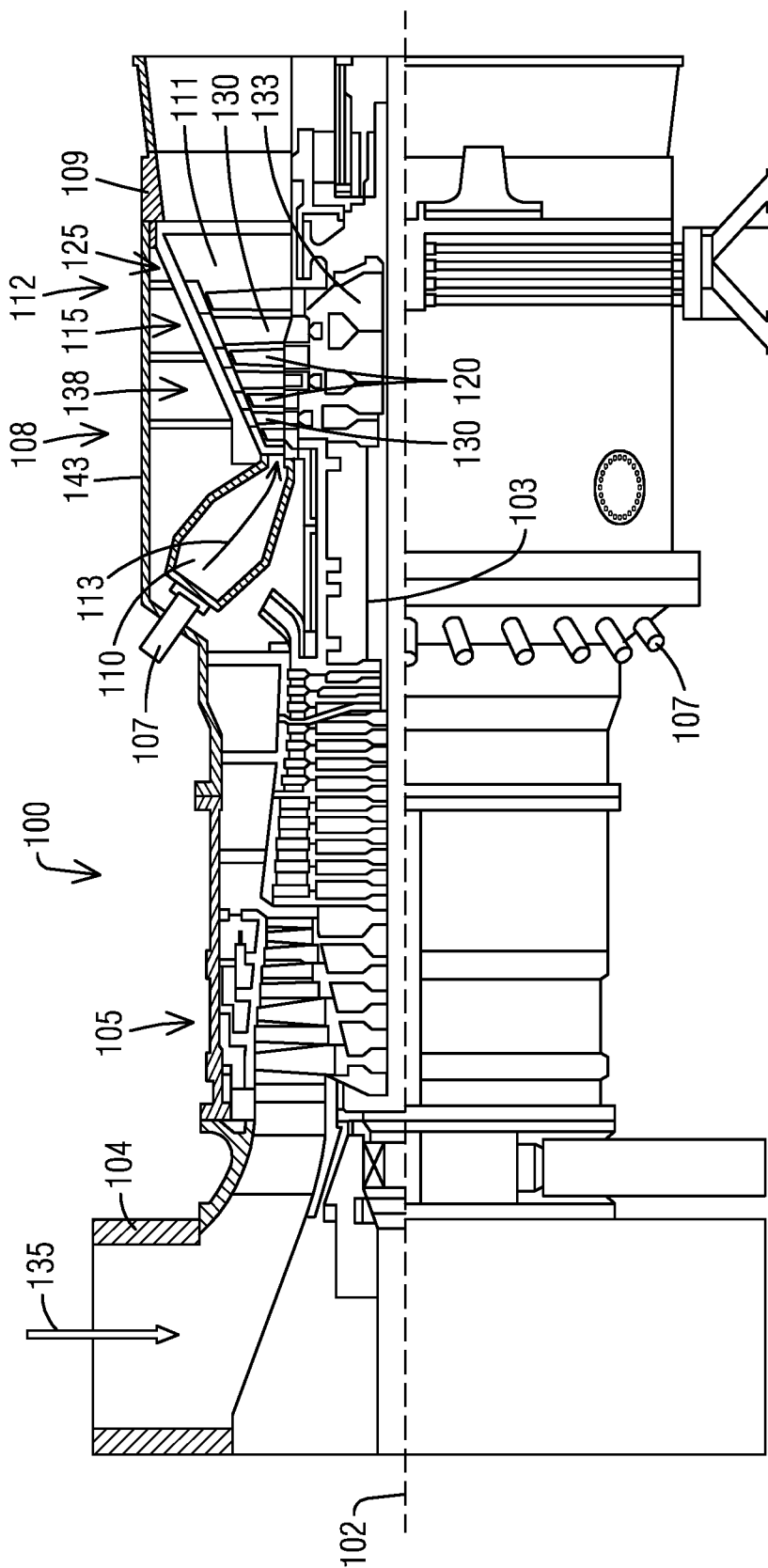

FIG. 1

FIG. 2

