

FIG. 1

200

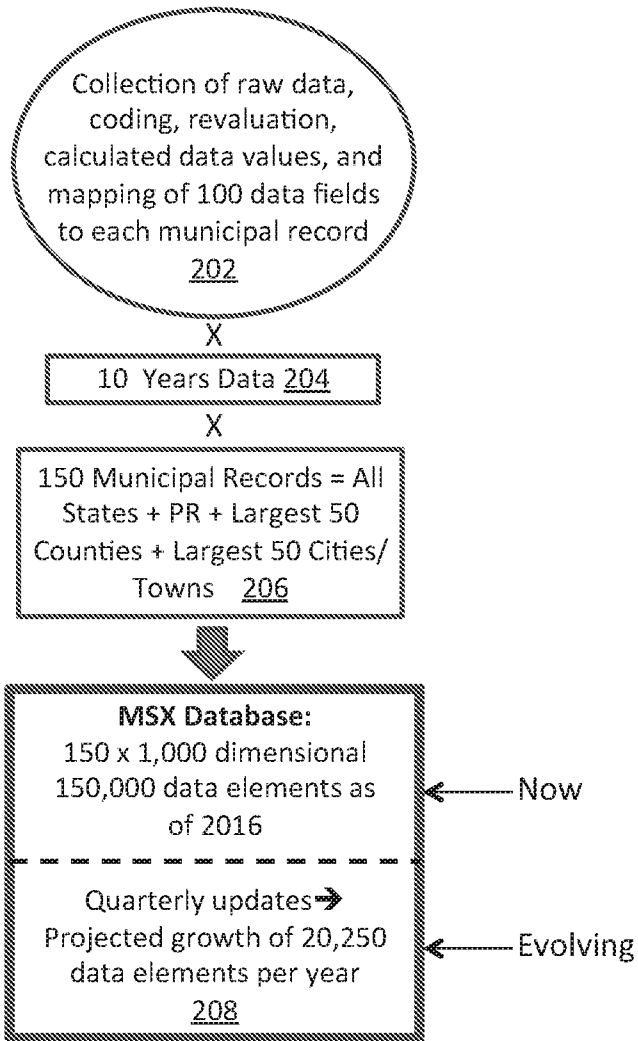

FIG. 2

DDP0001PCT

300A 302 304 3/18 306 308 310

↓ ↓ ↓ ↓ ↓ ↓ ↓

TYPE	LEVEL	DATA ITEM	SOURCE	FREQUENCY
DEMO	STATE	POPULATION	CENSUS/CPS	ANNUAL
DEMO	STATE	RACE	CENSUS/CPS	ANNUAL
DEMO	STATE	AGE	CENSUS/CPS	ANNUAL
DEMO	STATE	HOUSING UNITS	CENSUS/CPS	ANNUAL
DEMO	STATE	PER CAP INC	CENSUS/CPS	ANNUAL
DEMO	STATE	POPULATION FORECAST	CENSUS/CPS	ANNUAL
DEMO	STATE	MEDIAN VALUE OF OO HOUSING UNITS	CENSUS/CPS	ANNUAL
DEMO	STATE	EDUCATION ATTAINED	CENSUS/CPS	ANNUAL
DEMO	COUNTY	POPULATION	CENSUS/CPS	ANNUAL
DEMO	COUNTY	RACE	CENSUS/CPS	ANNUAL
DEMO	COUNTY	AGE	CENSUS/CPS	ANNUAL
DEMO	COUNTY	HOUSING UNITS	CENSUS/CPS	ANNUAL
DEMO	COUNTY	PER CAP INC	CENSUS/CPS	ANNUAL
DEMO	COUNTY	POPULATION FORECAST	CENSUS/CPS	ANNUAL
DEMO	COUNTY	MEDIAN VALUE OF OO HOUSING UNITS	CENSUS/CPS	ANNUAL
DEMO	COUNTY	EDUCATION ATTAINED	CENSUS/CPS	ANNUAL
DEMO	STATE	CHANGE IN HOUSE PRICES, % YR/YR	US FHF A/FRED	QUARTERLY
DEMO	COUNTY	CHANGE IN HOUSE PRICES, % YR/YR	US FHF A/FRED	QUARTERLY
DEMO	STATE	SAT	COLLEGE BOARD	ANNUAL
DEMO	CITIES AND TOWNS	SAT	COLLEGE BOARD	ANNUAL
DEMO	STATE	COMP OF ED FUNDING BY SOURCE: STATE, LOCAL, FED	CENSUS	ANNUAL
DEMO	CITIES AND TOWNS	MILL RATES	STATE BY STATE	LATEST
DESCRIPTIVE	STATE/COUNTY/CITY, TOWN	GEO TYPE	CAFR	ONE TIME
DESCRIPTIVE	STATE/COUNTY/CITY, TOWN	FY DATE	CAFR	ONE TIME
DESCRIPTIVE	STATE/COUNTY/CITY, TOWN	STATE	CAFR	ONE TIME
DESCRIPTIVE	STATE/COUNTY/CITY, TOWN	COUNTY	CAFR	ONE TIME
DESCRIPTIVE	STATE/COUNTY/CITY, TOWN	RANK BY REVENUE	COMPUTATION	LATEST
ECON	STATE	PERSONAL CONSUMPTION	BEA	QUARTERLY
ECON	STATE	REAL GDP	BEA	QUARTERLY
ECON	STATE	PERSONAL CONSUMPTION	BEA	QUARTERLY
ECON	STATE	PER CAPITAL INCOME	BEA	QUARTERLY
ECON	COUNTY	PER CAPITAL INCOME	BEA	QUARTERLY
ECON	MSA	PER CAPITAL INCOME	BEA	QUARTERLY
ECON	TOP 20 CITIES	PER CAPITAL INCOME	BEA	QUARTERLY
ECON	COUNTY	MEDIAN HH INCOME	CENSUS	ANNUAL
ECON	COUNTY	UNEMPLOYMENT	CENSUS	ANNUAL
ECON	STATE	UNEMPLOYMENT	BLS	QUARTERLY
ECON	MSA	UNEMPLOYMENT	BLS	QUARTERLY
ECON	STATE	REGIONAL PRICE PARITY	BEA	QUARTERLY
ECON	MSA	REGIONAL PRICE PARITY	BEA	QUARTERLY
FINANCIAL	STATE, COUNTY, CITY, TOWN	EXTERNAL AUDITOR	CAFR	LATEST
FINANCIAL	STATE, COUNTY, CITY, TOWN	GFOA	CAFR	LATEST
FINANCIAL	STATE, COUNTY, CITY, TOWN	INCOME TAX, PERSONAL	CAFR	ANNUAL
FINANCIAL	STATE, COUNTY, CITY, TOWN	INCOME TAX, CORPORATE	CAFR	ANNUAL
FINANCIAL	STATE, COUNTY, CITY, TOWN	SALES TAX	CAFR	ANNUAL
FINANCIAL	STATE, COUNTY, CITY, TOWN	EXCISE TAX	CAFR	ANNUAL
FINANCIAL	STATE, COUNTY, CITY, TOWN	PROPERTY TAX	CAFR	ANNUAL

FIG. 3A

DDP0001PCT

TYPE	LEVEL	DATA ITEM	SOURCE	FREQUENCY
FINANCIAL	STATE, COUNTY, CITY, TOWN	INHERITANCE/ESTATE TAX	CAFR	ANNUAL
FINANCIAL	STATE, COUNTY, CITY, TOWN	OTHER TAX	CAFR	ANNUAL
FINANCIAL	STATE, COUNTY, CITY, TOWN	TABACCO SETTLEMENT REV	CAFR	ANNUAL
FINANCIAL	STATE, COUNTY, CITY, TOWN	TRANSFERS --- UNREST	CAFR	ANNUAL
FINANCIAL	STATE, COUNTY, CITY, TOWN	TRANSFERS --- UNDER -- UNREST	CAFR	ANNUAL
FINANCIAL	STATE, COUNTY, CITY, TOWN	FEES FOR SERVICES	CAFR	ANNUAL
FINANCIAL	STATE, COUNTY, CITY, TOWN	PREMIUMS FOR UNEMPL	CAFR	ANNUAL
FINANCIAL	STATE, COUNTY, CITY, TOWN	PREMIUM FOR OTHER INS	CAFR	ANNUAL
FINANCIAL	STATE, COUNTY, CITY, TOWN	LOTTERY REVENUE	CAFR	ANNUAL
FINANCIAL	STATE, COUNTY, CITY, TOWN	HIGHER ED REVENUE	CAFR	ANNUAL
FINANCIAL	STATE, COUNTY, CITY, TOWN	LIQUOR CONTROL REV	CAFR	ANNUAL
FINANCIAL	STATE, COUNTY, CITY, TOWN	OTHER BUS REV	CAFR	ANNUAL
FINANCIAL	STATE, COUNTY, CITY, TOWN	INVESTMENT INCOME	CAFR	ANNUAL
FINANCIAL	STATE, COUNTY, CITY, TOWN	TRANSFERS, EDUCATION	CAFR	ANNUAL
FINANCIAL	STATE, COUNTY, CITY, TOWN	TRANSFERS, TRANSPORTATION	CAFR	ANNUAL
FINANCIAL	STATE, COUNTY, CITY, TOWN	TRANSFERS, TRANSPORTATION	CAFR	ANNUAL
FINANCIAL	STATE, COUNTY, CITY, TOWN	TRANSFERS, HUMAN SERVICES	CAFR	ANNUAL
FINANCIAL	STATE, COUNTY, CITY, TOWN	TRANSFERS, OTHER RESTRICT	CAFR	ANNUAL
FINANCIAL	STATE, COUNTY, CITY, TOWN	EXPEND ON EDU	CAFR	ANNUAL
FINANCIAL	STATE, COUNTY, CITY, TOWN	EXPEND ON TRANS	CAFR	ANNUAL
FINANCIAL	STATE, COUNTY, CITY, TOWN	EXPEND ON SOCIAL SERV	CAFR	ANNUAL
FINANCIAL	STATE, COUNTY, CITY, TOWN	EXPEND ON COMMUNITY	CAFR	ANNUAL
FINANCIAL	STATE, COUNTY, CITY, TOWN	EXPEND ON UNEMPL INS	CAFR	ANNUAL
FINANCIAL	STATE, COUNTY, CITY, TOWN	EXPEND ON SAFETY	CAFR	ANNUAL
FINANCIAL	STATE, COUNTY, CITY, TOWN	EXPEND ON GEN GOV	CAFR	ANNUAL
FINANCIAL	STATE, COUNTY, CITY, TOWN	EXPEND ON DEBT INTEREST	CAFR	ANNUAL
FINANCIAL	STATE, COUNTY, CITY, TOWN	EXPEND ON OTHER INSUR	CAFR	ANNUAL
FINANCIAL	STATE, COUNTY, CITY, TOWN	EXPEND ON LIQUOR CONT	CAFR	ANNUAL
FINANCIAL	STATE, COUNTY, CITY, TOWN	EXPEND ON LOTTERY	CAFR	ANNUAL
FINANCIAL	STATE, COUNTY, CITY, TOWN	EXPEND ON HIGHER ED	CAFR	ANNUAL
FINANCIAL	STATE, COUNTY, CITY, TOWN	CLAIMS PD UNEMPL INS	CAFR	ANNUAL
FINANCIAL	STATE, COUNTY, CITY, TOWN	CLAIMS PD OTHER INS	CAFR	ANNUAL
FINANCIAL	STATE, COUNTY, CITY, TOWN	OTHER BUSINESS REV	CAFR	ANNUAL
FINANCIAL	STATE, COUNTY, CITY, TOWN	OTHER BUSINESS EXPENSES	CAFR	ANNUAL
FINANCIAL	STATE, COUNTY, CITY, TOWN	REVENUE FROM OTHER CU	CAFR	ANNUAL
FINANCIAL	STATE, COUNTY, CITY, TOWN	EXPENDITURE FROM OTHER CU	CAFR	ANNUAL
FINANCIAL	STATE, COUNTY, CITY, TOWN	TANGIBLE ASSETS, REAL EST	CAFR	ANNUAL
FINANCIAL	STATE, COUNTY, CITY, TOWN	TANGIBLE ASSETS, REAL EST, REVALUED	CAFR	ANNUAL
FINANCIAL	STATE, COUNTY, CITY, TOWN	OTHER TANGIBLE ASSETS	CAFR	ANNUAL
FINANCIAL	STATE, COUNTY, CITY, TOWN	ASSETS, INVESTED	CAFR PENSION	ANNUAL
FINANCIAL	STATE, COUNTY, CITY, TOWN	LIABILITIES PBO	CAFR PENSION	ANNUAL
FINANCIAL	STATE, COUNTY, CITY, TOWN	LIABILITIES REVALUED PBO	CAFR PENSION	ANNUAL
FINANCIAL	STATE, COUNTY, CITY, TOWN	LIABILITIES ABO	CAFR PENSION	ANNUAL
FINANCIAL	STATE, COUNTY, CITY, TOWN	LIABILITIES REVALUED ABO	CAFR PENSION	ANNUAL
FINANCIAL	STATE, COUNTY, CITY, TOWN	NUMBER OF MUNICIPAL EMPLOYEES	CAFR	ANNUAL
MARKET	STATE, COUNTY, CITY, TOWN	BOND, GO OR EQUIV	MSRB	ANNUAL AT FY
MARKET	STATE, COUNTY, CITY, TOWN	RATINGS	MSRB	ANNUAL AT FY

FIG. 3B

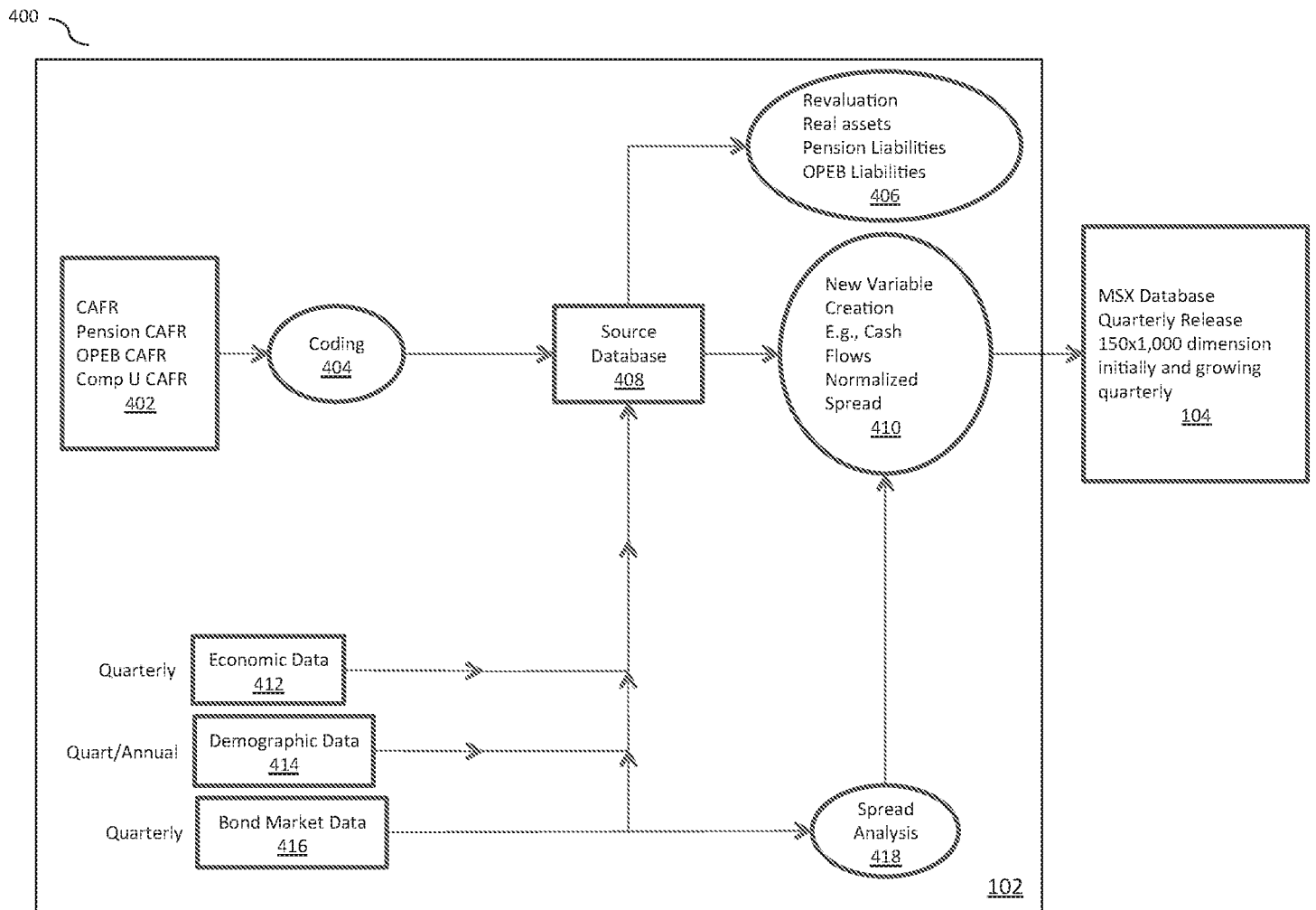

FIG. 4

DDP0001PCT

6/18

Muni Entity	State	Municip Type	FY	Fin Statement	Section	Type	Function	Activity	Classification	Value
NY	NY	State	2015	IS Gov Primary	Program Rev	Charges	Business	SUNY	Higher Ed	4095
NY	NY	State	2015	IS Gov Primary	Program Rev	Charges	Business	CUNY	Higher Ed	647
MI	MI	State	2015	IS Component	Program Rev	Charges	Comp Unit_D	WMU	Higher Ed	394
MI	MI	State	2015	IS Component	Program Rev	Charges	Primary	Education	Education	-3752
FL	FL	State	2014	IS Gov Primary	Program Rev	Charges	Business	Pre-paid	Higher Ed	913
FL	FL	State	2014	IS Gov Primary	Program Rev	Charges	Comp Unit_D	UF	Higher Ed	2886
FL	FL	State	2014	IS Component	Program Rev	Charges	Primary	Education	Education	236

FIG. 5

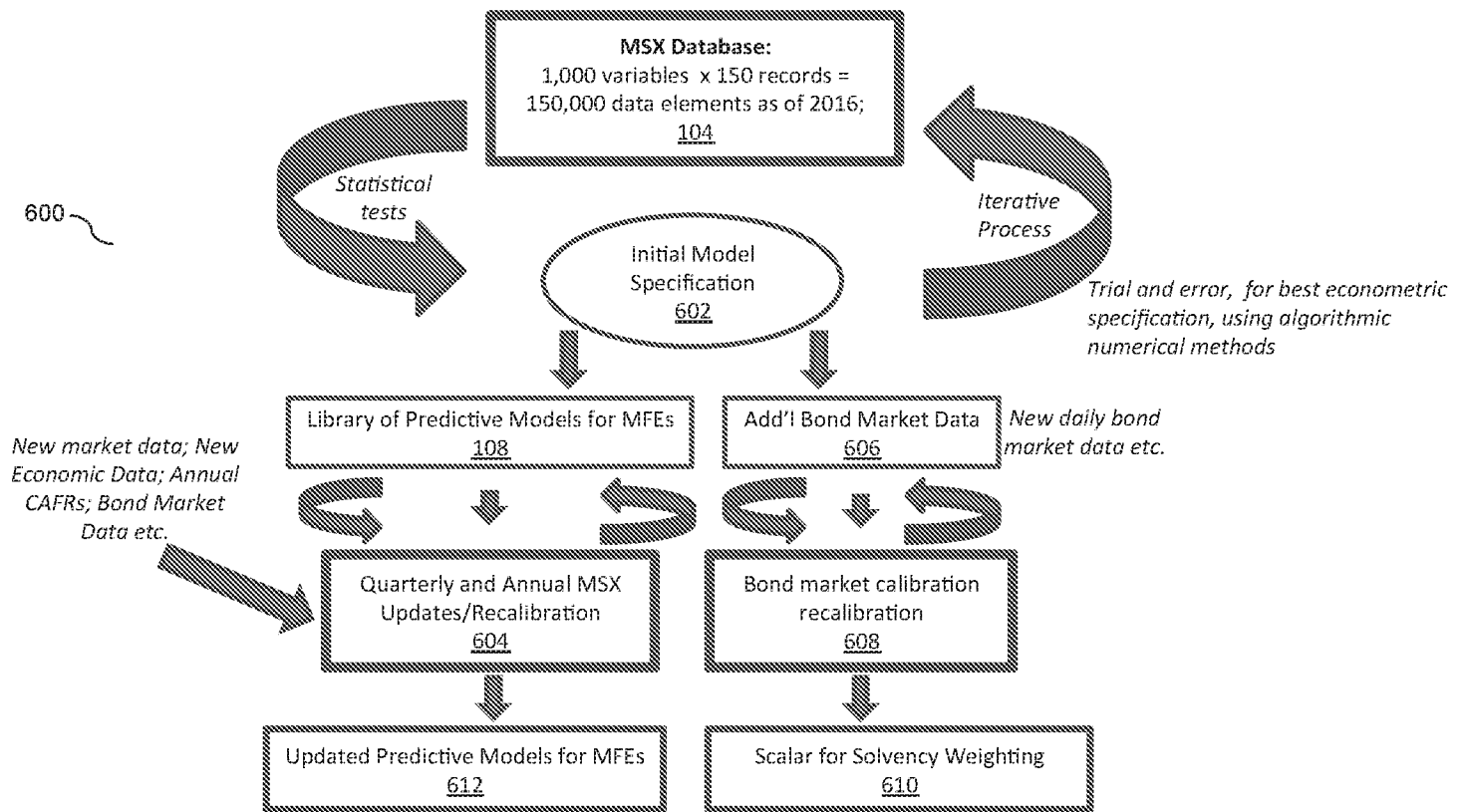

FIG. 6

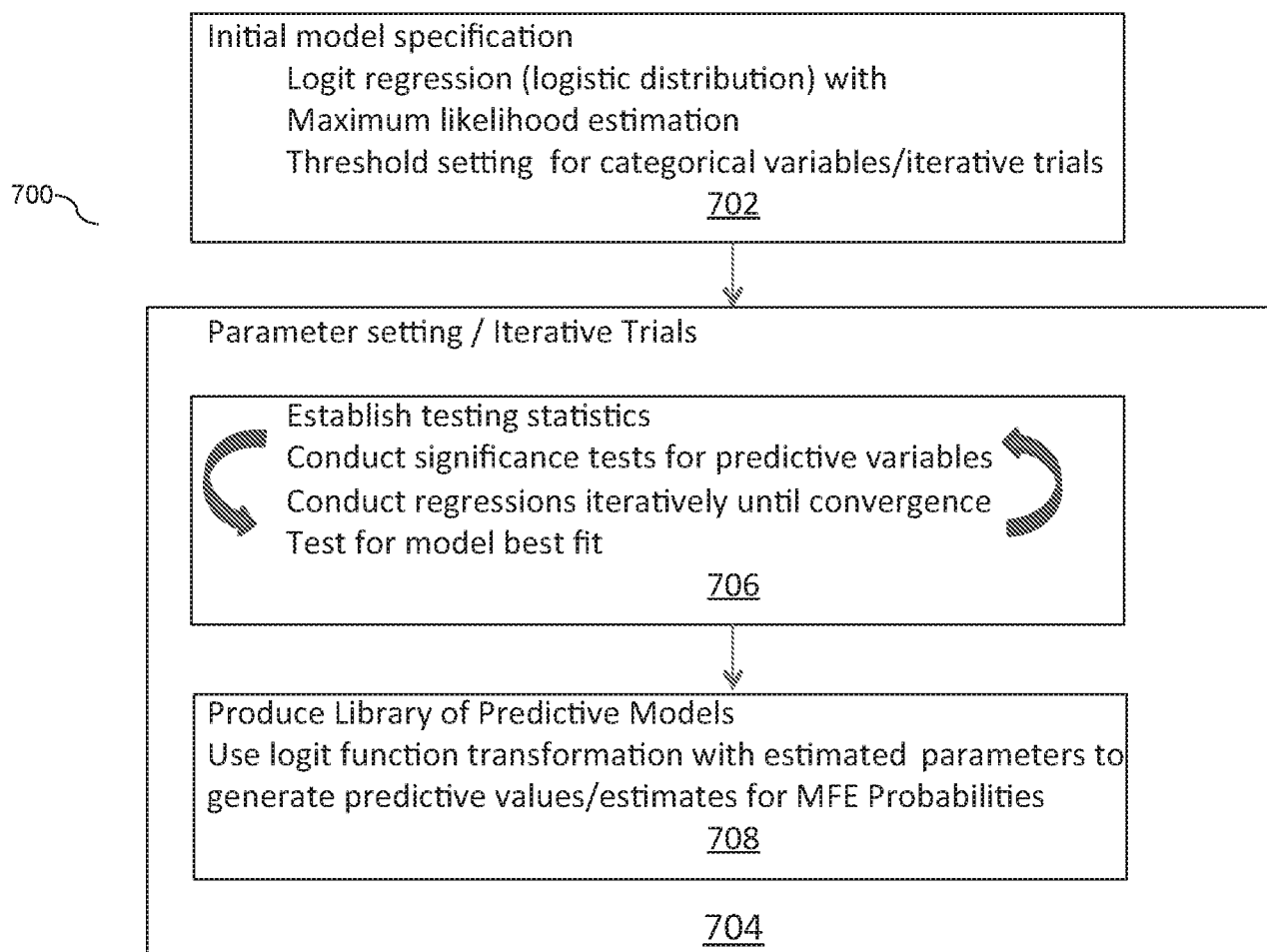

FIG. 7

DDP0001PCT

9/18

800

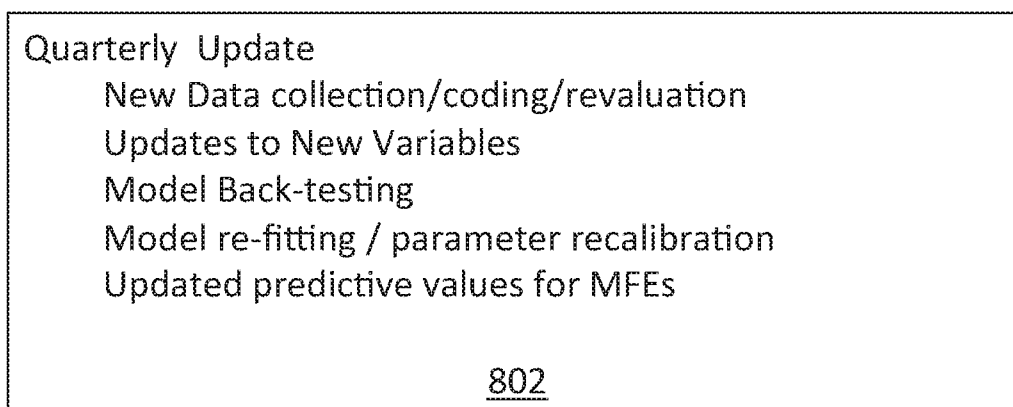

FIG. 8

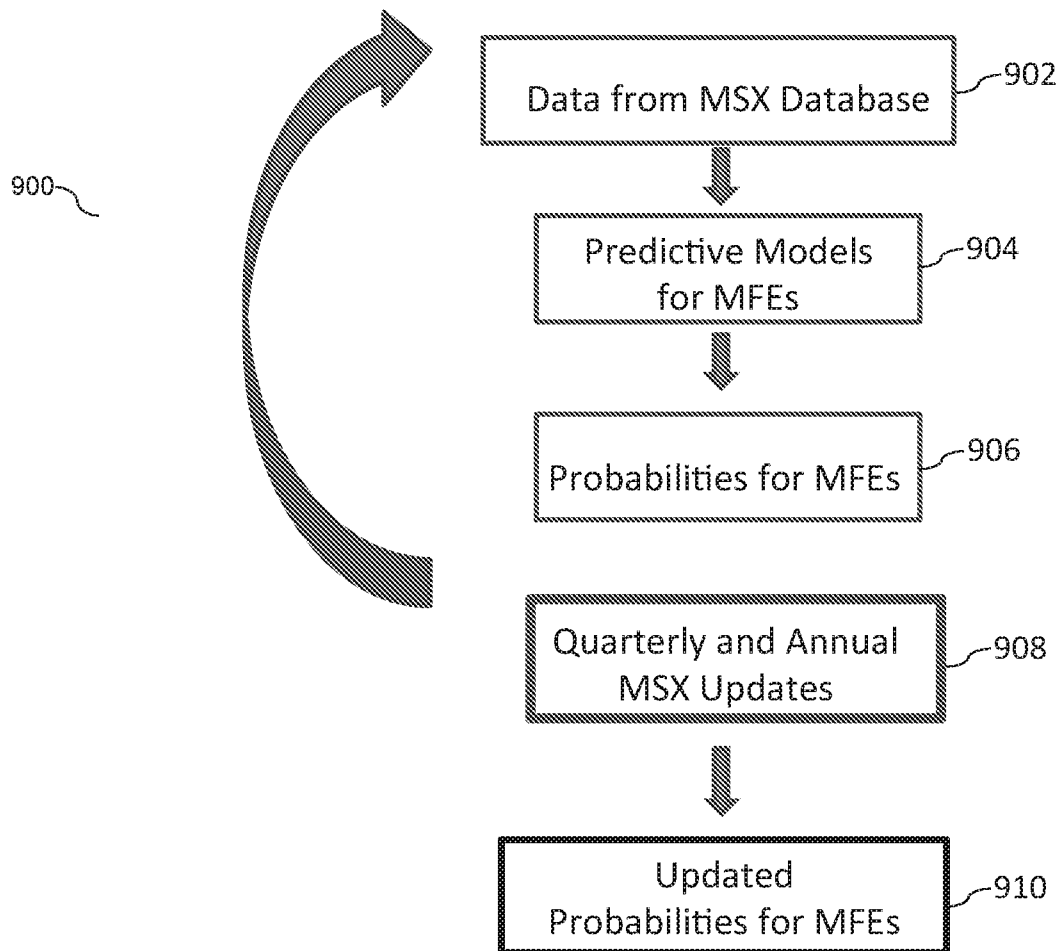

FIG. 9

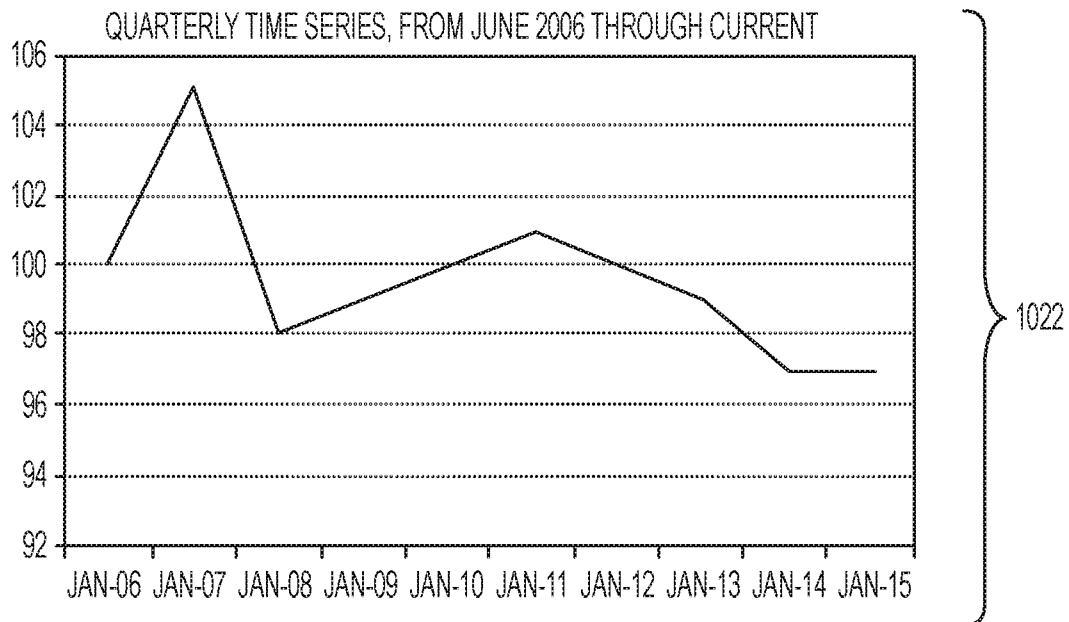
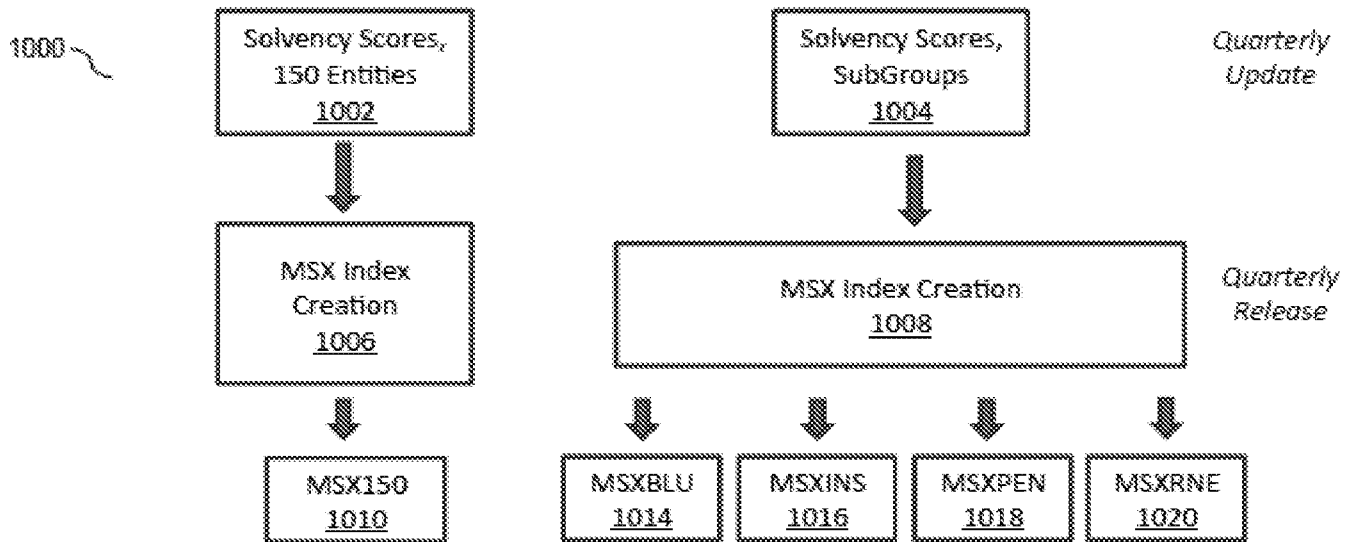

FIG. 10

12/18

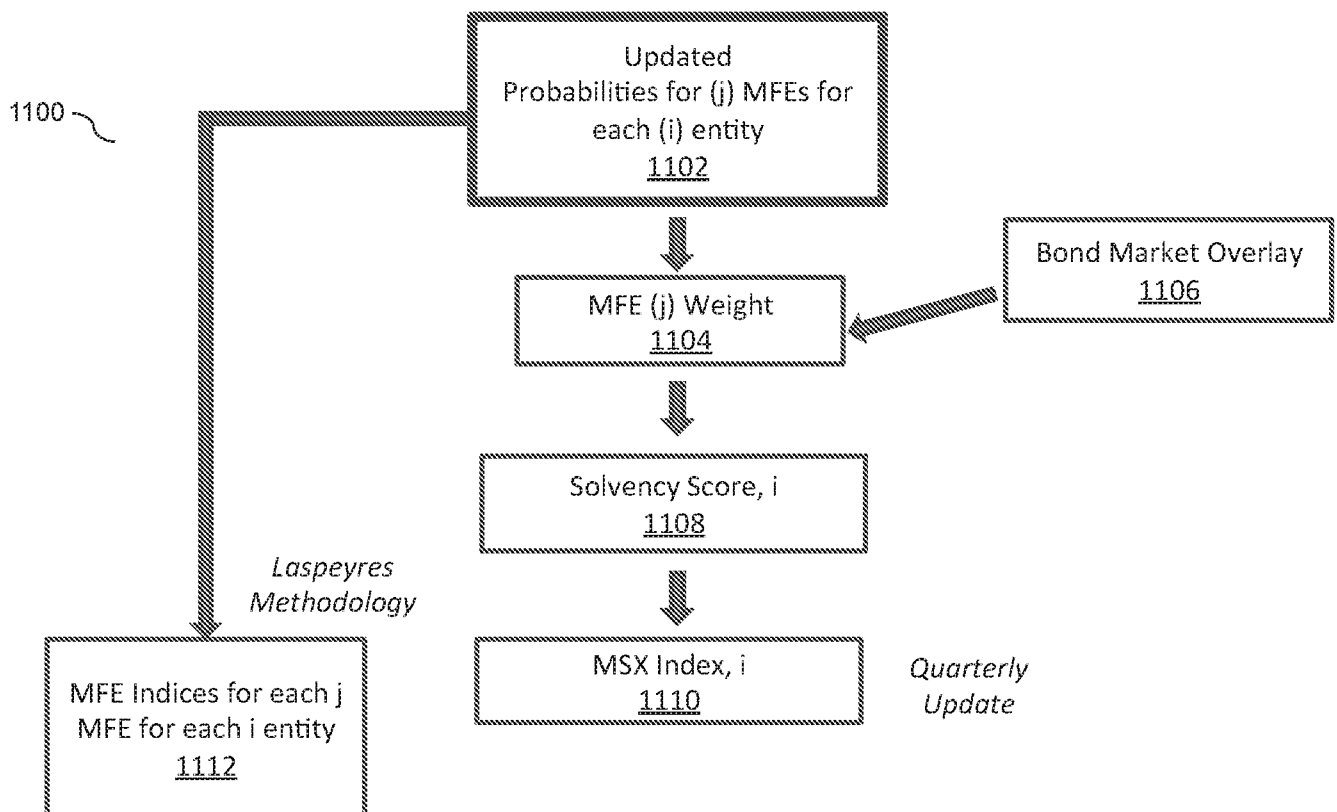

FIG. 11

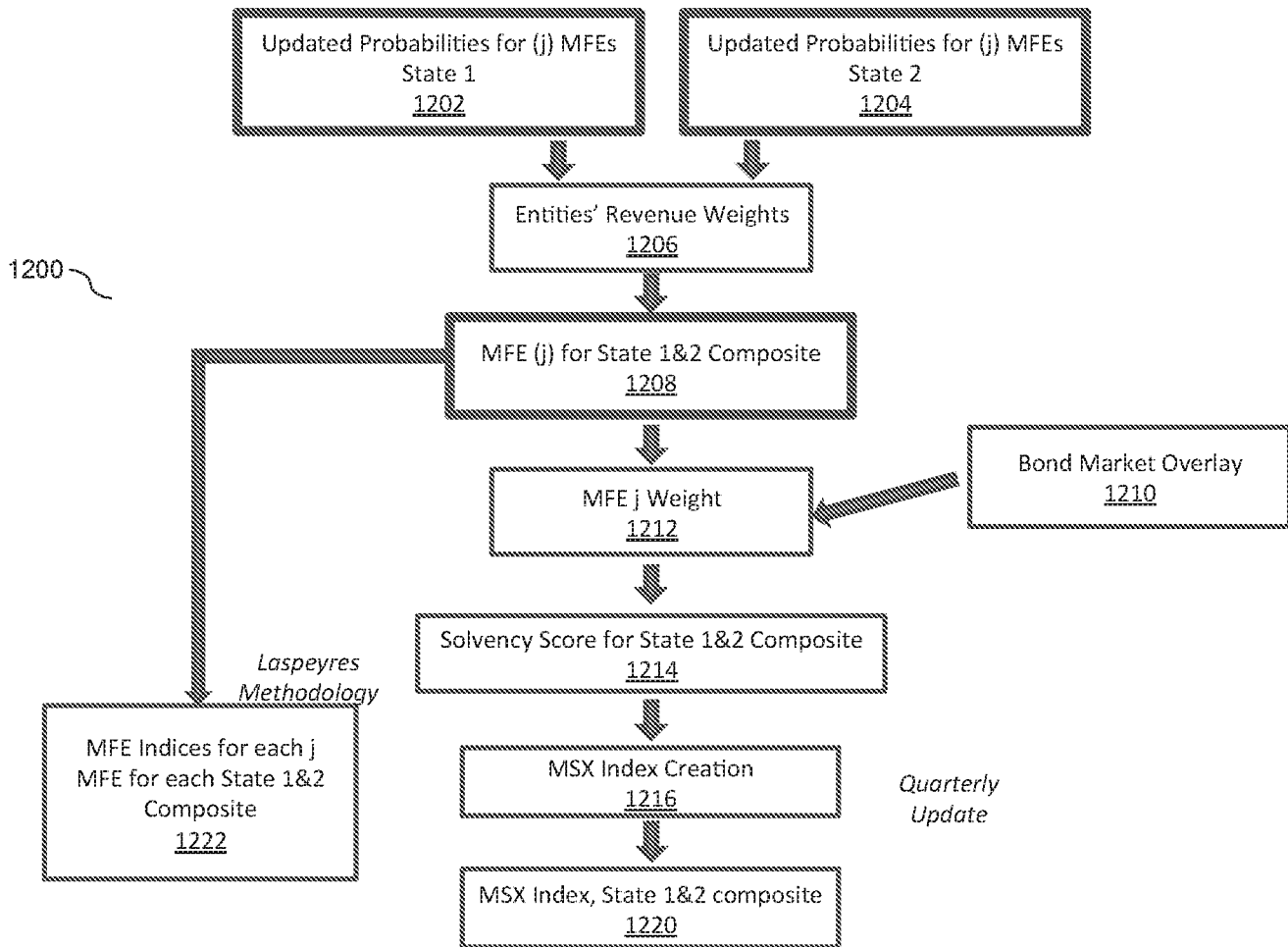

FIG. 12

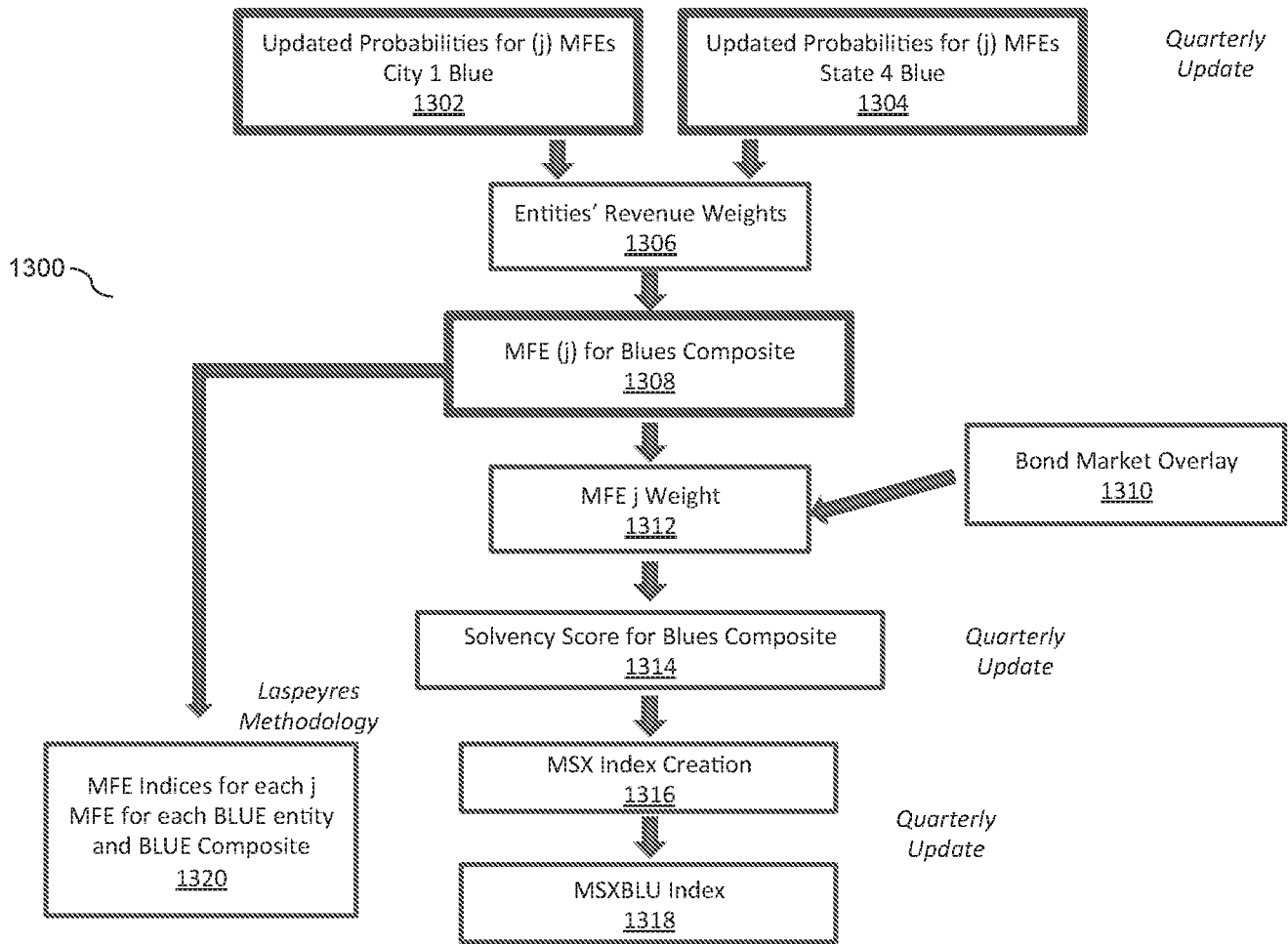

FIG. 13

DDP0001PCT

15/18

1400

		1 SOLVENCY SCORE AND SOLVENCY INDEX FOR EACH MUNICIPALITY (i)				SOLVENCY		
		Tax Increase	ion Underfunding	Essential Servs	Cash Flow	SCORE	MSX,i	
1402	State 1	2006	14.00	58.00	25.00	18.00	27.5392	100.000
	State 1	2007	14.00	59.00	25.00	18.00	27.7530	100.214
	State 1	2008	15.00	60.00	22.00	18.00	27.3665	99.827
	State 2	2006	27.00	22.00	9.00	8.00	15.9947	100.000
	State 2	2007	26.00	21.00	9.00	12.00	16.5525	100.558
	State 2	2008	26.00	20.00	8.00	11.00	15.8008	99.806
		2 SOLVENCY SCORE AND SOLVENCY INDEX FOR A GROUP/SUBSET OF MUNICIPALITIES				SOLVENCY		
						SCORE	MSX, group	
1404	States 1&2	2006	22.67	34.00	14.33	11.33	19.8429	100.000
	States 1&2	2007	22.00	33.67	14.33	14.00	20.2860	100.443
	States 1&2	2008	22.33	33.33	12.67	13.33	19.6560	99.813
		3 MFE INDEX VALUE FOR EACH MUNI FOR EACH MFE						
1406	State 1	2006	100.00	100.00	100.00	100.00		
	State 1	2007	100.00	101.00	100.00	100.00		
	State 1	2008	101.00	102.00	97.00	100.00		
	State 2	2006	100.00	100.00	100.00	100.00		
	State 2	2007	99.00	99.00	100.00	104.00		
	State 2	2008	99.00	98.00	99.00	103.00		
		4 MFE INDEX VALUE FOR EACH MFE FOR A GROUPING OF MUNICIPALITIES						
1408	States 1&2	2006	100.00	100.00	100.00	100.00		
	States 1&2	2007	99.33	99.67	100.00	102.67		
	States 1&2	2008	99.67	99.33	98.33	102.00		

FIG. 14

DDP0001PCT

16/18

1500

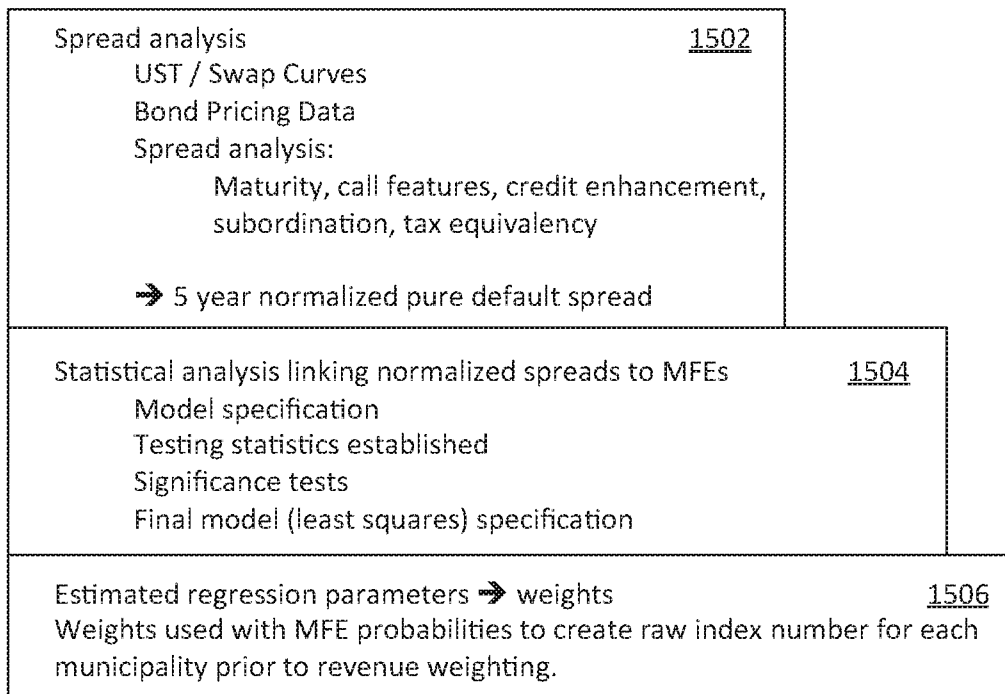

FIG. 15

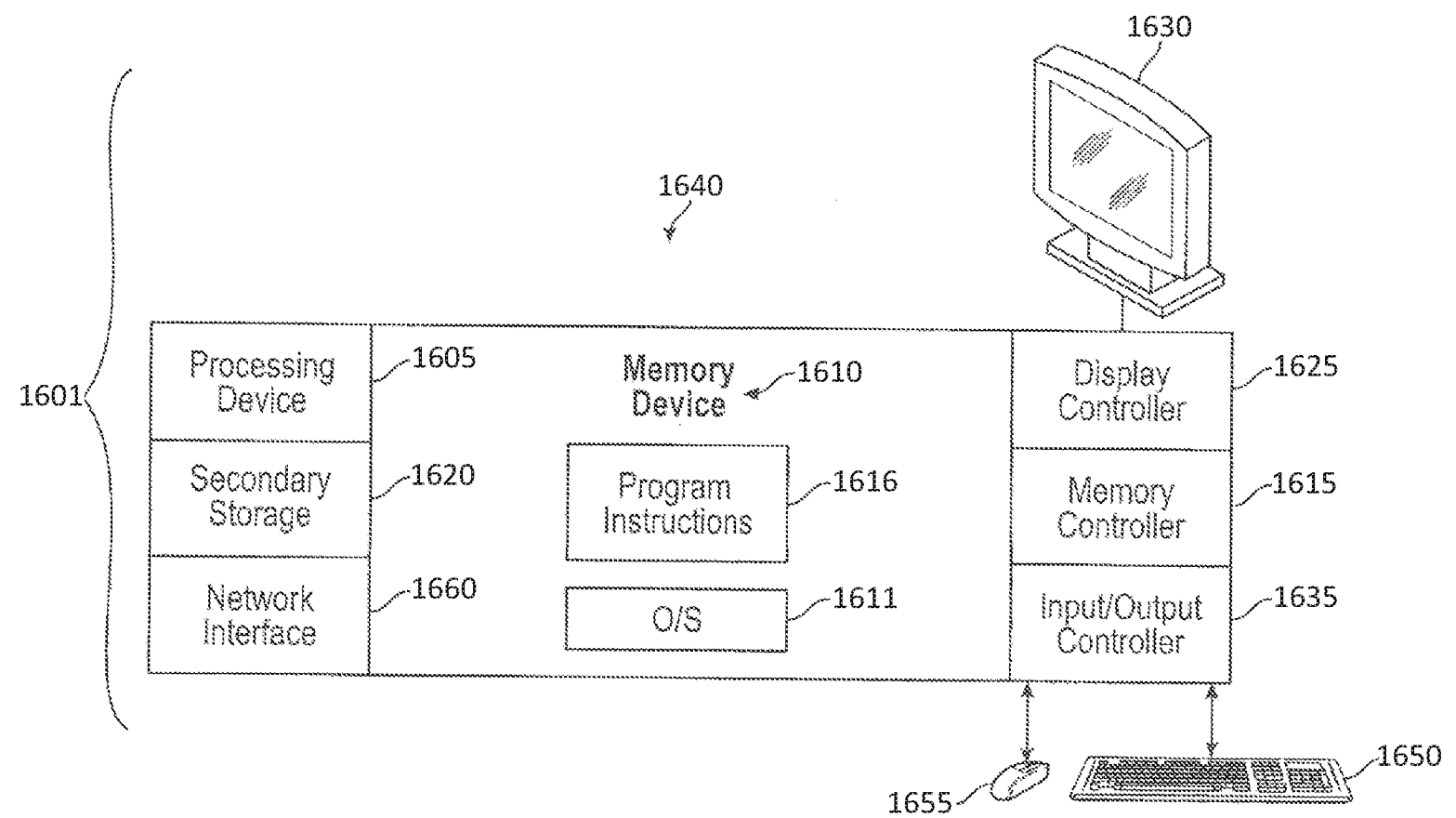

FIG. 16

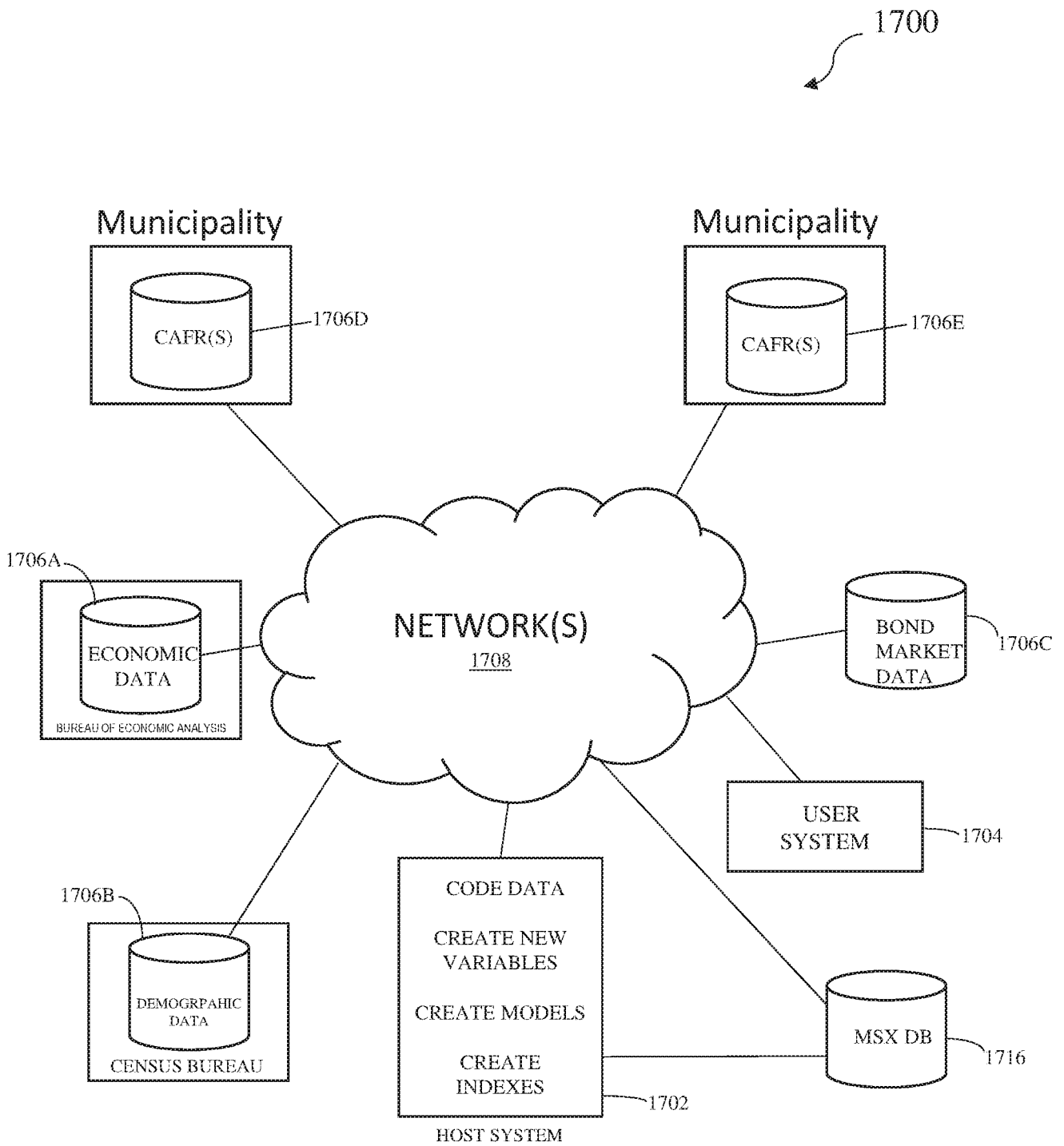

FIG. 17