

[도1]

TaqMan/Stem-loop primer

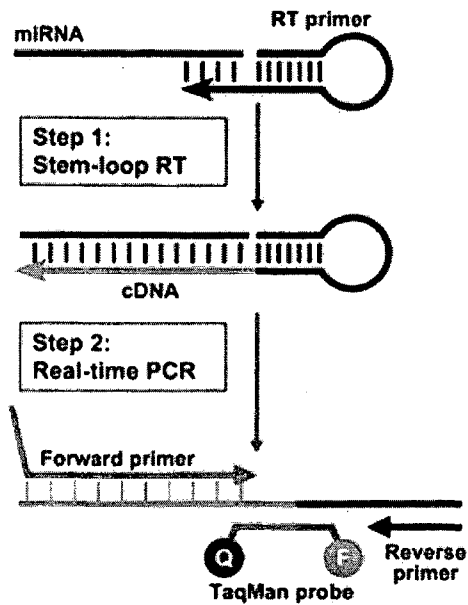

Sigma, et al/Poly-A Tailing

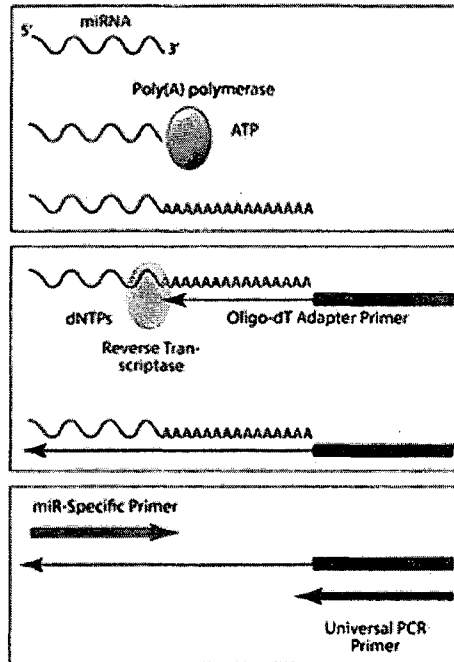

[도2]

Adenylation



Reverse-Transcription (cDNA 합성)

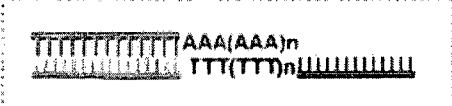

Real-time PCR

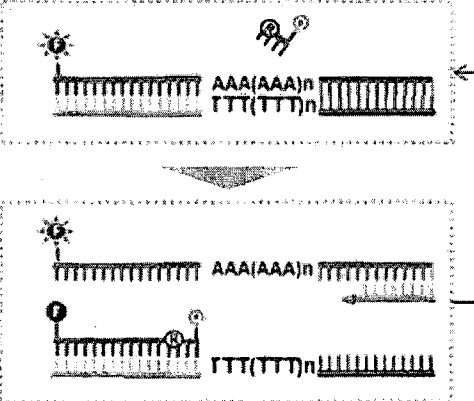

1/2/1

[도3]

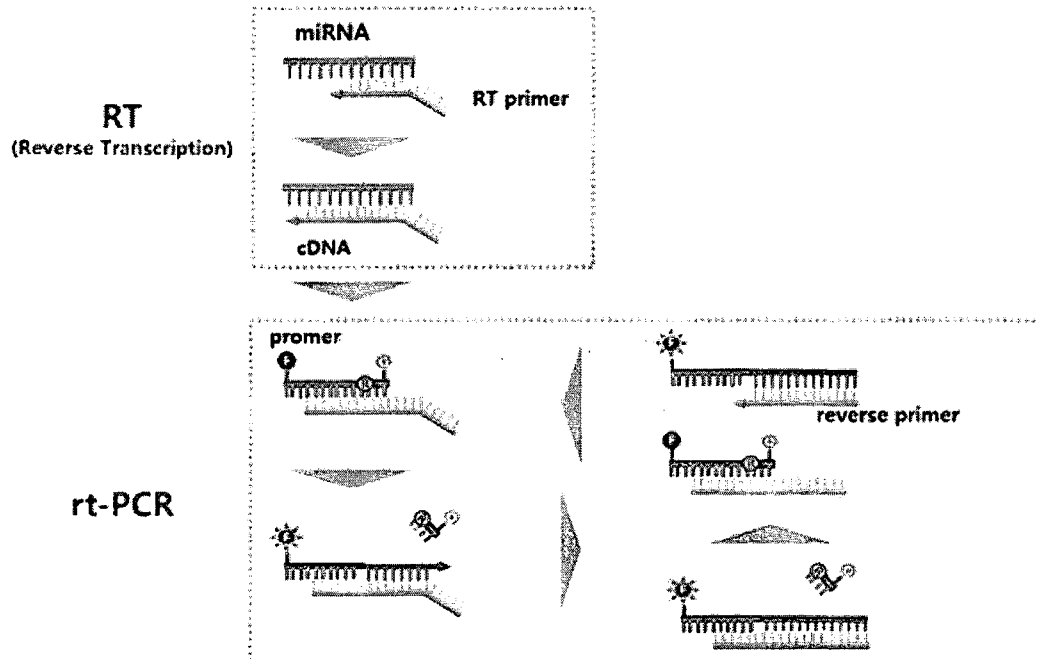

[도4]

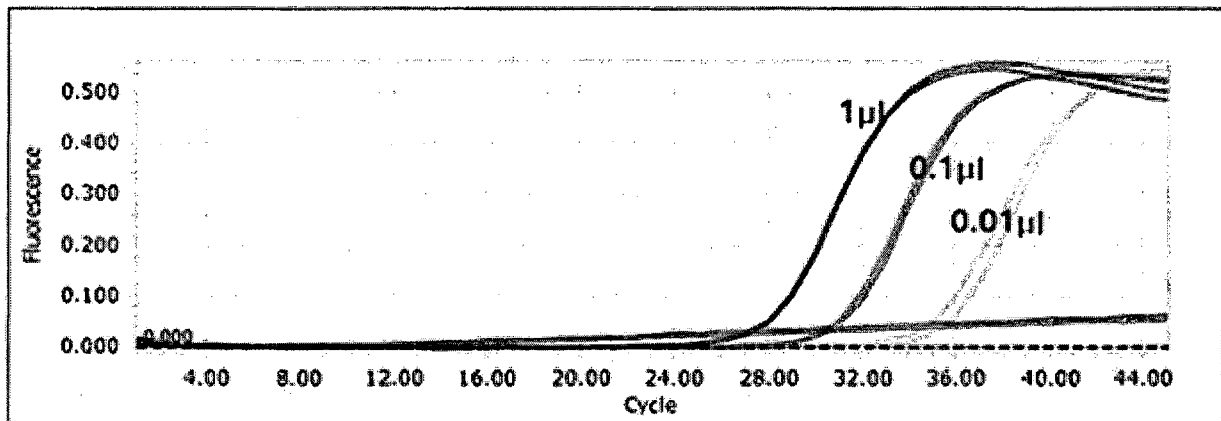

[도5]

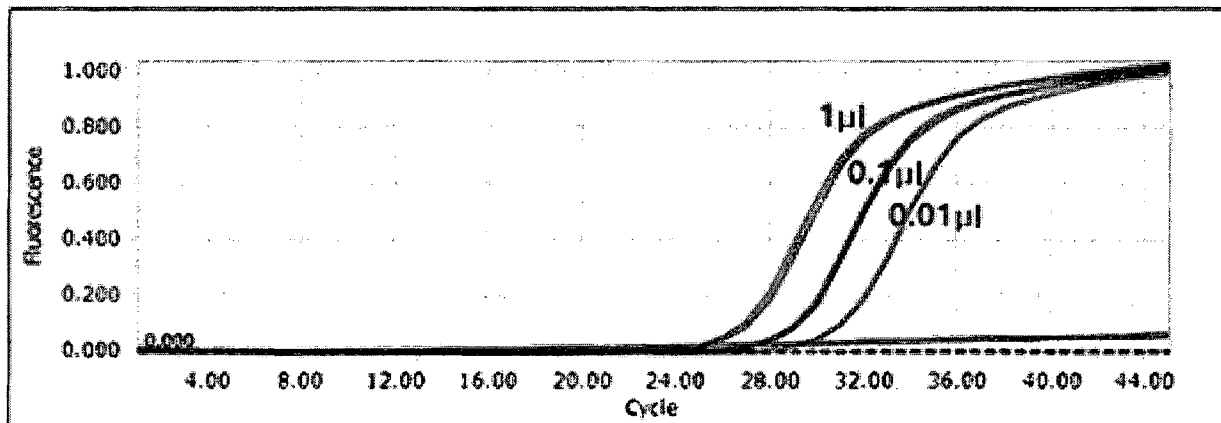

1/2/2

[E6]

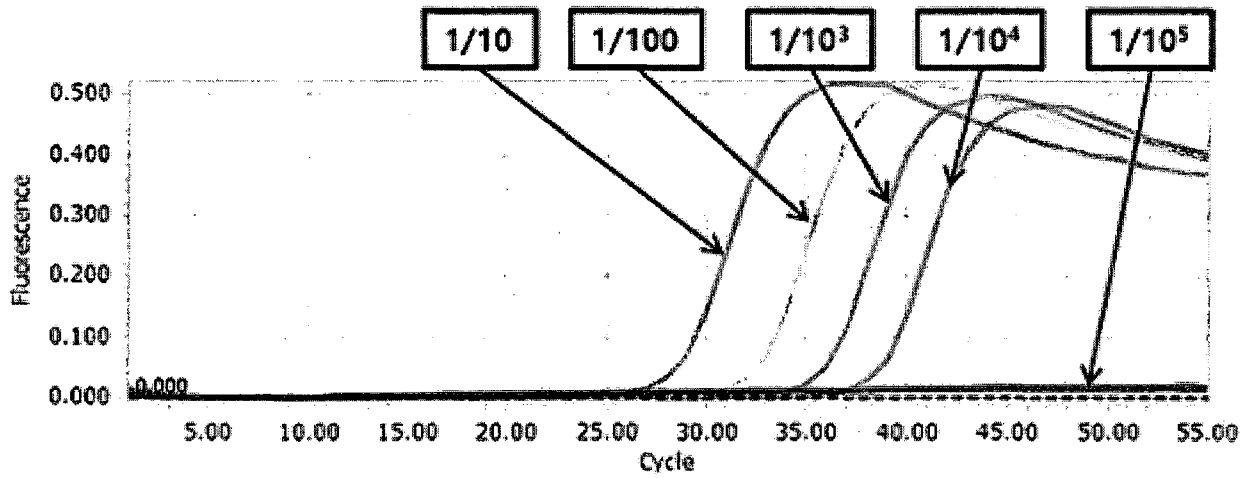

[E7]

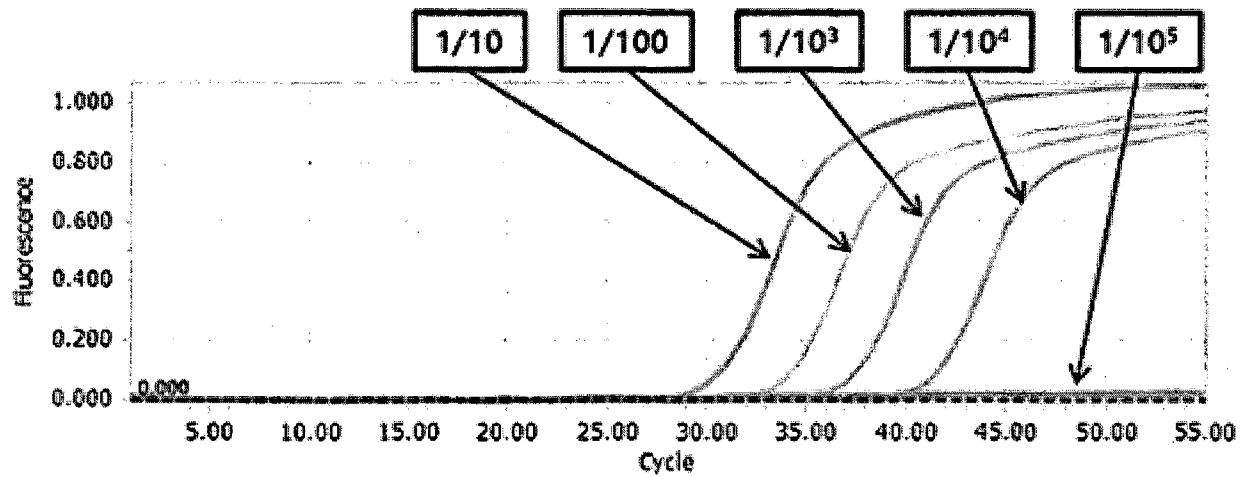

[E8]

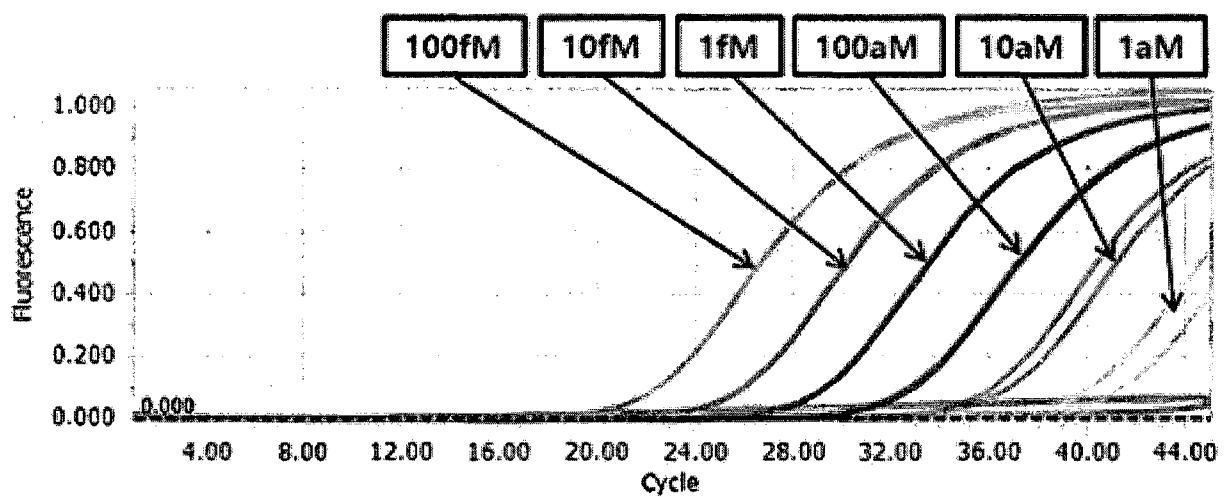

2/2

[도9]

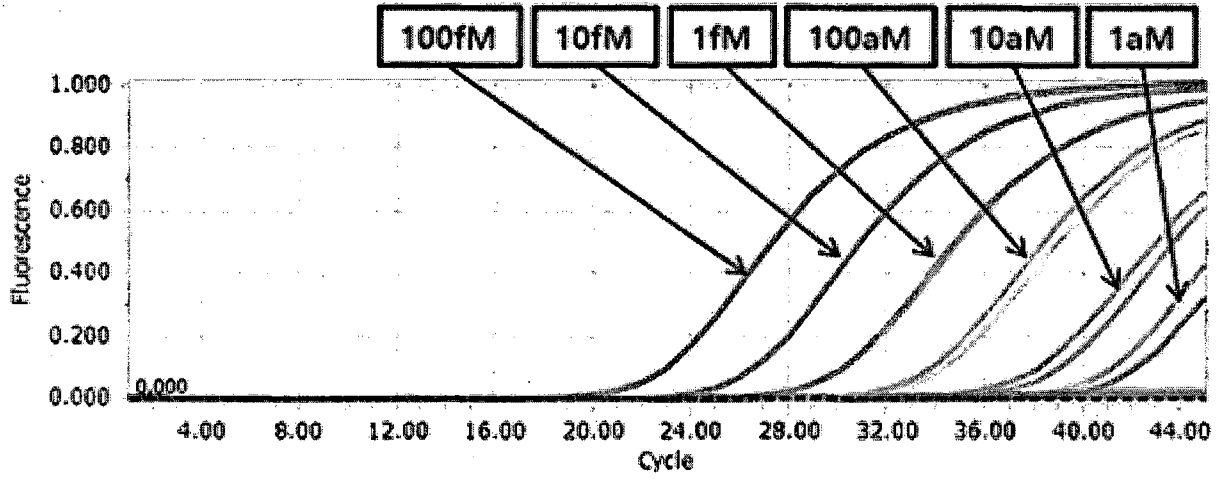

[도10]

