

Fig. 2

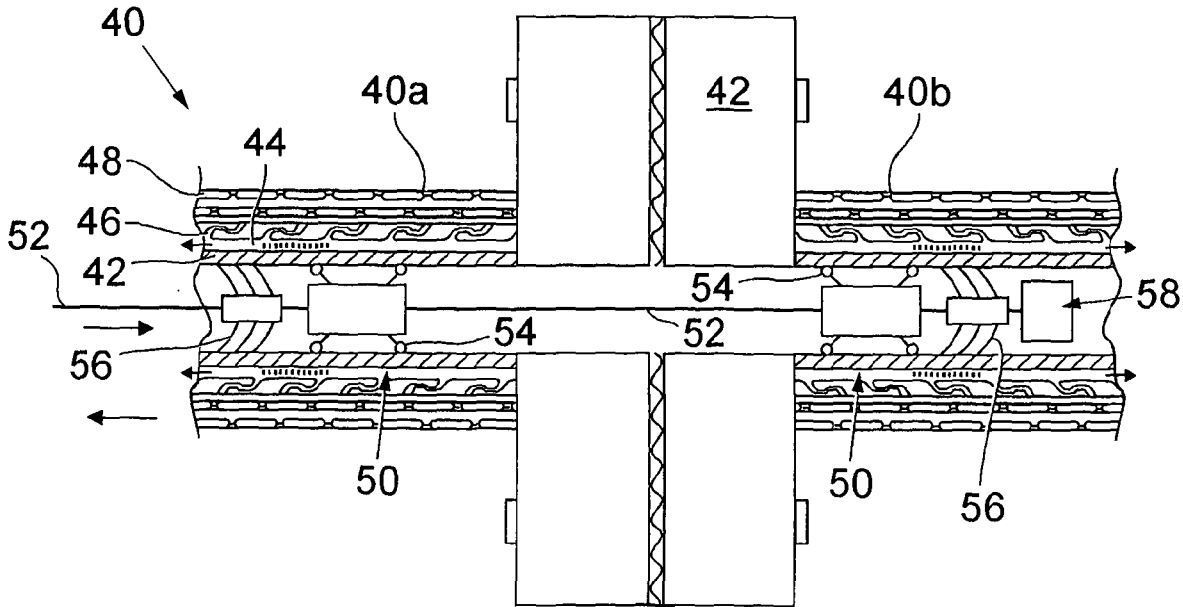

Fig. 3

3 / 3

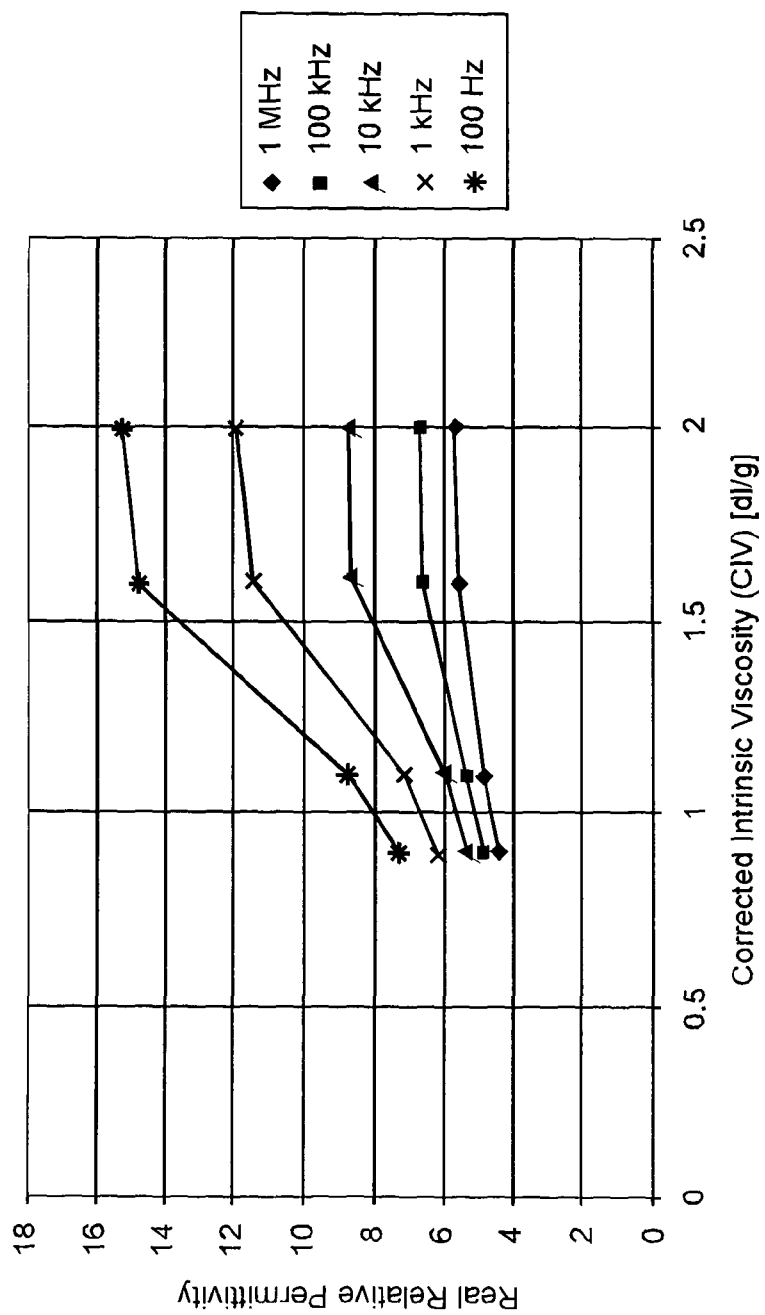

Fig. 4