

Fig. 2a

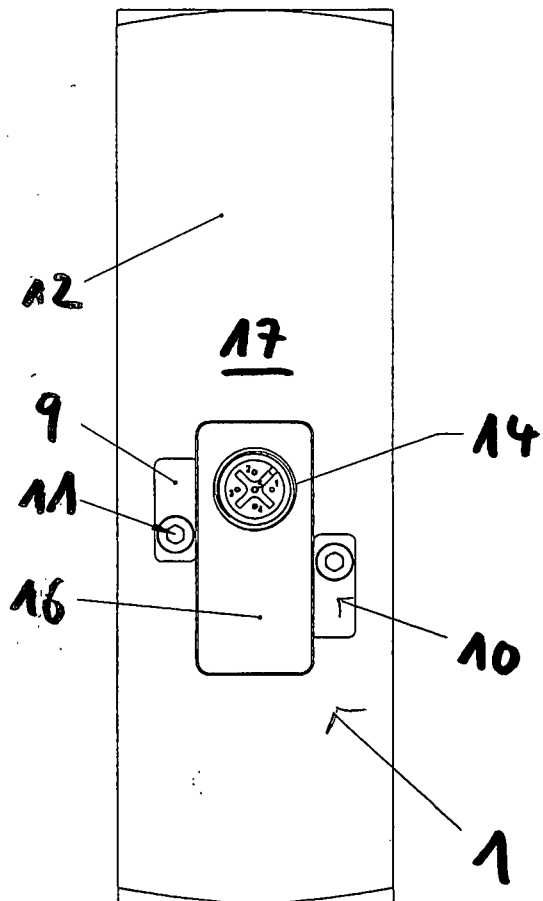

Fig. 2b

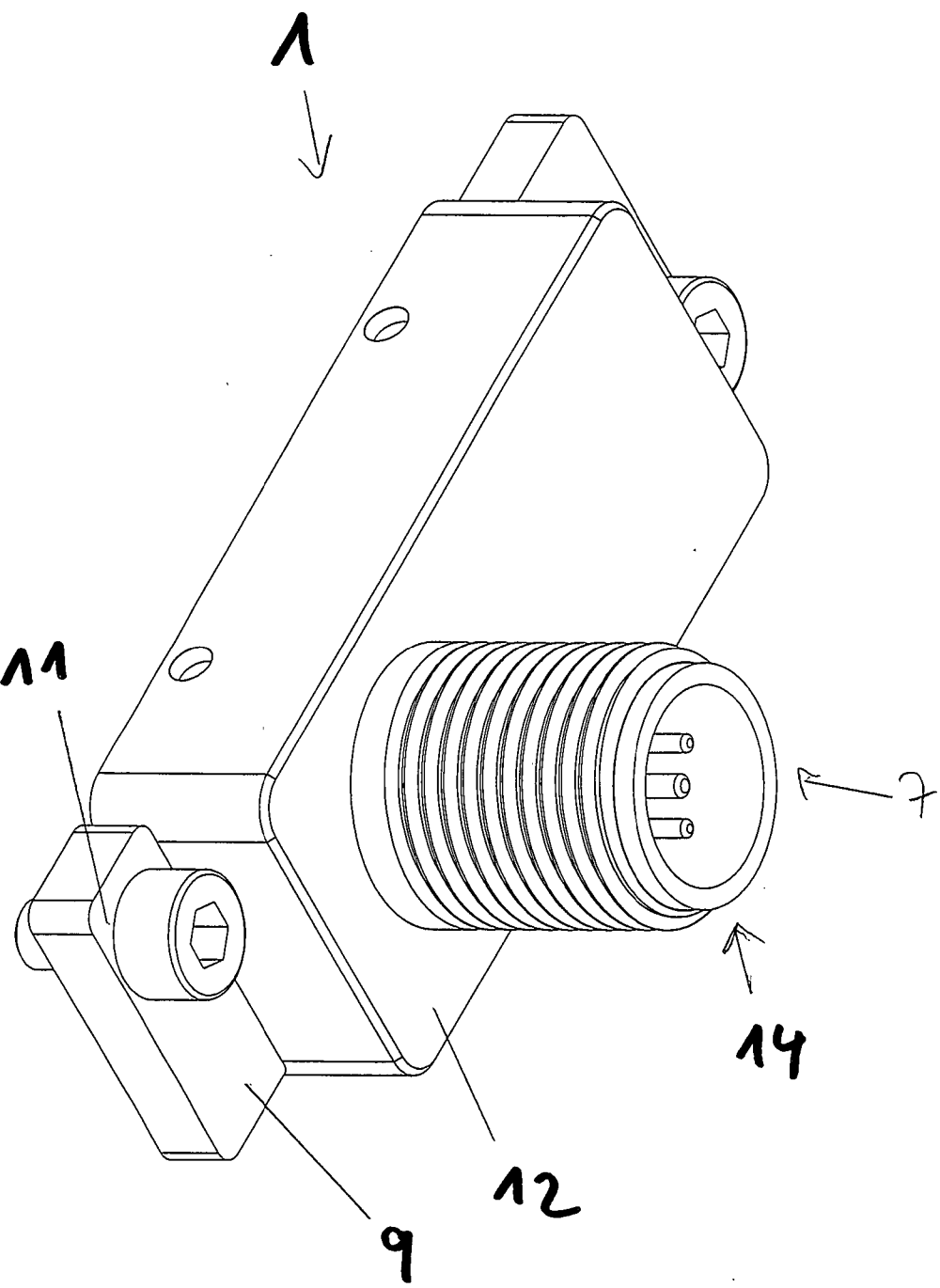

Fig. 3